



GIODI

inspiration
of
light



GIODI inspiration of light
is a brand of:



Inspiration of light

Il campionario aziendale è articolato in due diverse linee di prodotto, che utilizzano linguaggi espressivi diversi tra loro, sempre accomunati però da una stessa filosofia progettuale e da una stessa passione di GIODI per la luce.

Prodotti dalla spiccata vocazione al design e alla ricerca tecnologica, che si proiettano verso il futuro con un abbondante utilizzo di fonti luminose a LED.

Apparecchi di illuminazione tecnica e commerciale orientati a risolvere le esigenze illuminotecniche con una grande attenzione al risparmio energetico e al controllo degli scenari luminosi.

The products are distributed through two different product lines, which use very different expressive styles, yet sharing the very same planning philosophy and the same passion for Lighting.

Products characterised by a vocation for design and innovative technology, looking at the future with a massive use of LED technology.

Technical and commercial lighting, created specifically for architects, contractors, interior designers and electrical wholesalers, paying great attention to energy savings and the control of luminous scenarios.

GIODI stellt zwei Marken hauptsächlich vor, welche von einwandfreier Qualität, strengen Planungskriterien und hohen stilistischen Standards kenngzeichnet werden.

Die Premium-Marke von GIODI, die von bekannten Designern entwickelt und konzipiert wurde, vereint neueste LED-Technologie und Materialien in außergewöhnlichem Design.

Das technische Bereich, wo das Unternehmen als Marktführer gilt und verfügt weltweit über die wohl breiteste Produktpalette von Systemen, Profi-Downlights, LED Produkten usw in unterschiedlichen Designs.

Les produits sont distribués par deux marques différentes pour satisfaire n'importe quelle demande, du produit technique au produit de design, du produit décoratif au produit pour le secteur commercial.

Le produit haut de gamme, de très grande qualité et au design exclusif avec les avantages de la nouvelle technologie à LED.

La estrategia de la Compañía es proyectar, fabricar y distribuir productos agrupados en dos diferentes líneas

Productos de design y de forma innovadora, caracterizados por la innovación técnica de los LEDs.



GIODI

Una collezione di prodotti decorativi per uso abitativo e residenziale, con le forme pure e le linee essenziali di un design sempre attuale, capace di inserirsi in qualsiasi contesto architettonico.

Decorative lighting for domestic and residential use, characterised by the pure and essential lines of a timeless design, fitting into any architectural environment.

Wohnraumleuchtenartikel, welche Atmosphäre, Stimmungen und Emotionen schaffen. Tradition und Innovation zusammen für diese Kollektion mit klaren Linien, funktionellem Design und keinen Schnörkeln.

.Gamme de luminaires contemporains avec une polyvalence remarquable et un style indémodable et hautement décoratif.

Aparatos de iluminación para uso técnico comercial.

Colección de punto de luz para uso del hogar con diseño moderno.





SHADOW

Design Matteo Ragni

È una forma che dialoga con un'icona del paesaggio domestico: l'abat-jour. I materiali e la luce fanno il resto: il diffusore in metacrilato, quando la luce è accesa diventa un pretesto per trasformare Shadow in un oggetto luminoso dalla forte presenza iconica, e il metallo a specchio che trasforma la luce in ombra. Un'ombra che si proietta come un'eclissi lungo i bordi, oppure più lontano, su di un muro.

Lampada polifunzionale, trova impiego nella camera da letto come nel soggiorno. E' certamente un oggetto di design, essenziale nelle forme e pulizia delle linee. Struttura in metacrilato Opale, disponibile in un'unica finitura Bianco, lastra frontale a Specchio. L'illuminazione è data da una lampada fluorescente compatta da 24w.

At first sight it seems to be a classic abat-jour; but soon we realise it is unique and different. The combination of different materials, i.e. metal/mirror and methacrylate, achieves a result that surprises: the light from the diffuser subtly illuminates the perimeter of the mirror creating a warm and pleasant atmosphere, projecting the shadow along the borders and even farther onto the wall.

Polyfunctional lamp fitting properly any residential area, characterised by sobre yet elegant design. Body made of opal methacrylate, available in white with a mirror on the front side. For use with a 2G11 24W bulb.



SHADOW M147.01

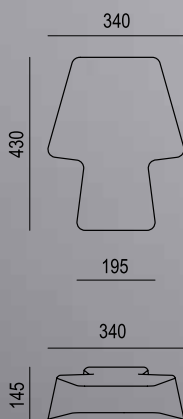

Materiali/Materials:

Diffusore in metacrilato - specchio
Methacrylate diffuser - mirror

Elettrificazione /Electrics:

1x2G11 24W



Colore/Color:

Bianco
White

* lampadine incluse / blub included



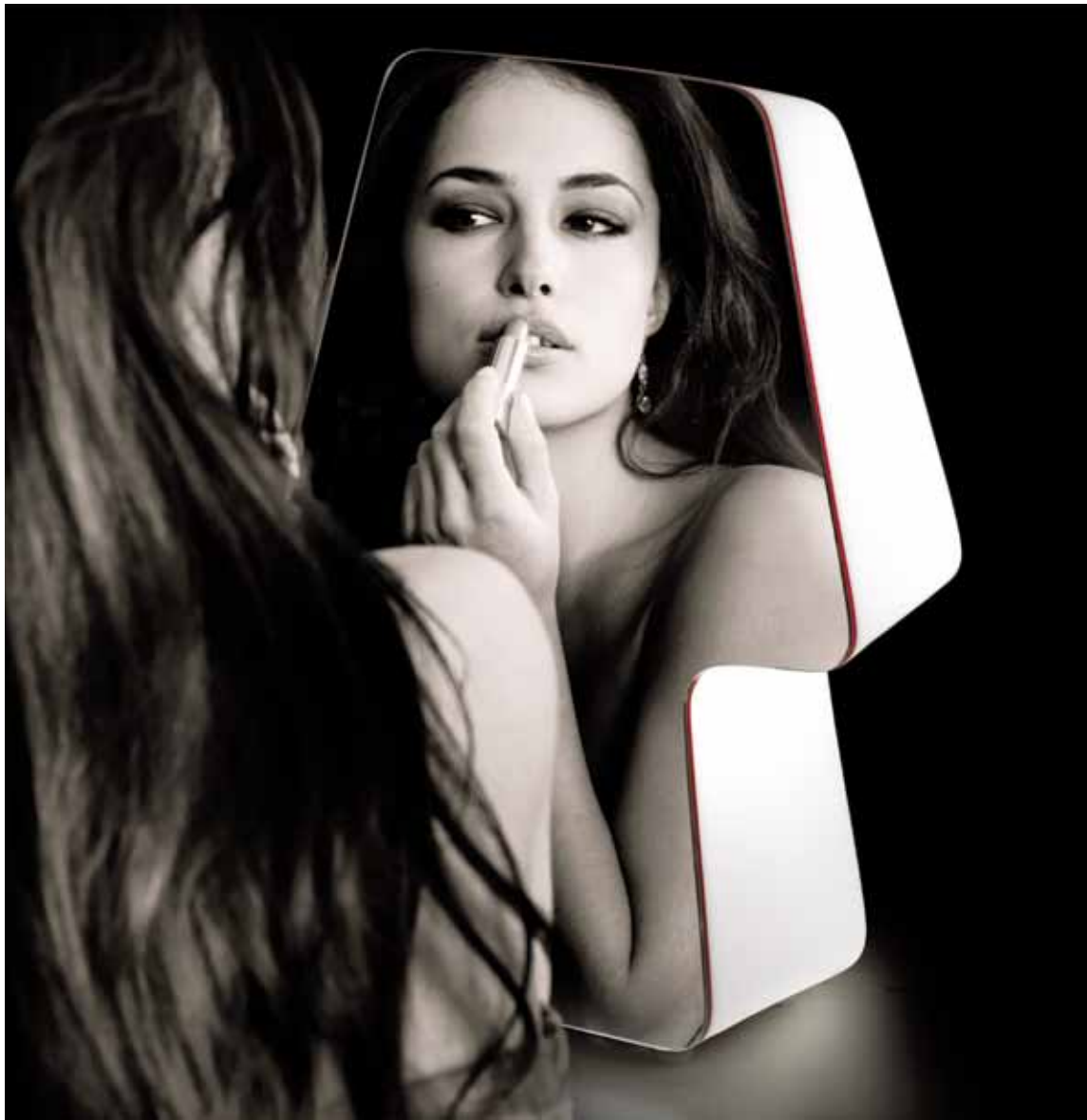



NIGHT&DAY

Design Joe Velluto

LED
SMD



Una elegante sospensione che pur svolgendo la sua abituale funzione nasconde un lato pressoché romantico. Alla sua accensione piccoli punti si illuminano come stelle in un cielo notturno...per trovare anche nel più classico degli oggetti un lato ludico e inaspettato.

A very elegant pendant luminaire with a romantic touch, compact and with a great personality. It looks particularly effective when it is illuminated with a number of small points of LED lights starring the diffuser. Perfect to provide elegance in any place requiring soft and elegant lighting effects.

M143.01

M143.02

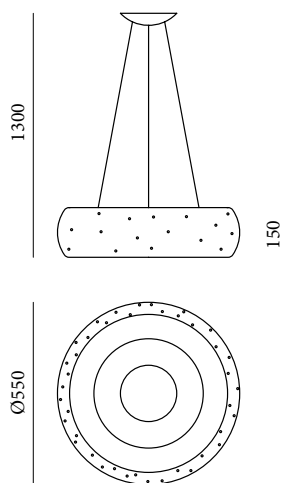

Materiali/Materials:

Struttura in alluminio nero o bianco,
vetro soffiato opale
White or Black aluminium frame,
opal blown glass

Elettrificazione /Electrics:

1x2GX13 22W + 1x2GX13 55W
+ 24xLed



Colore/Color:
Nero
Black



Colore/Color:
Bianco
White

* lampadine incluse / blub included

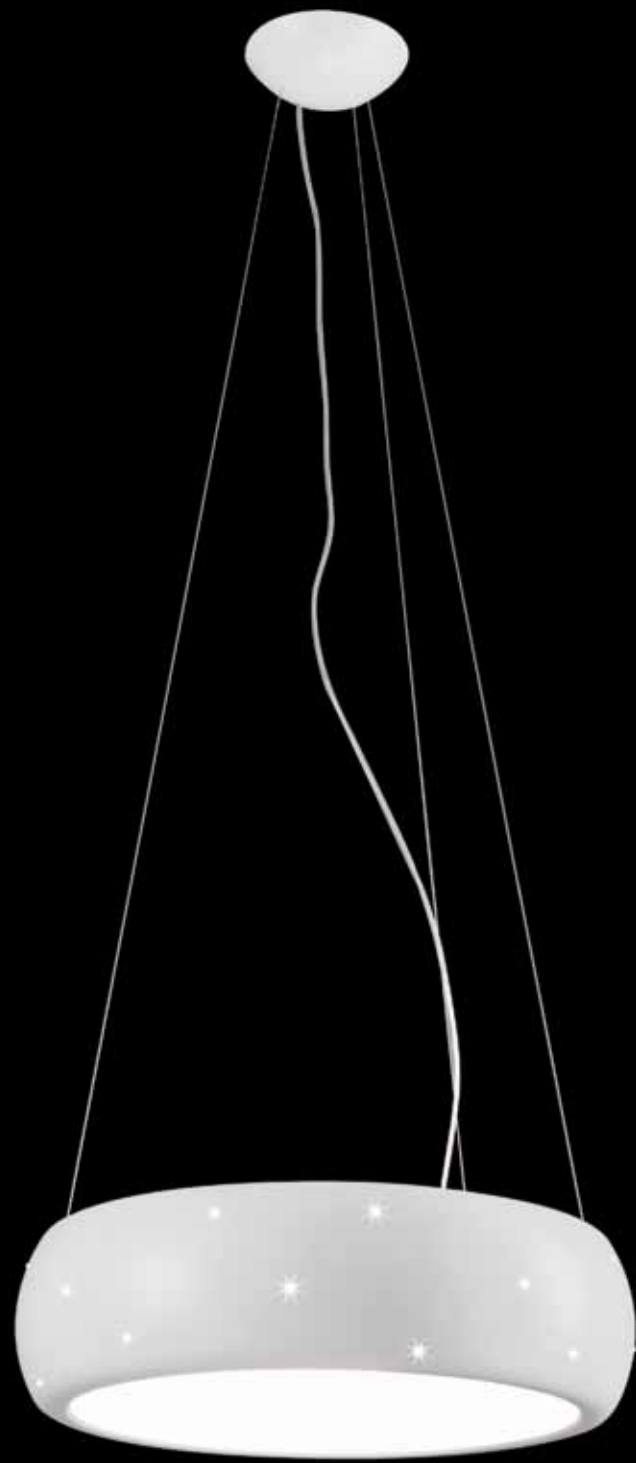





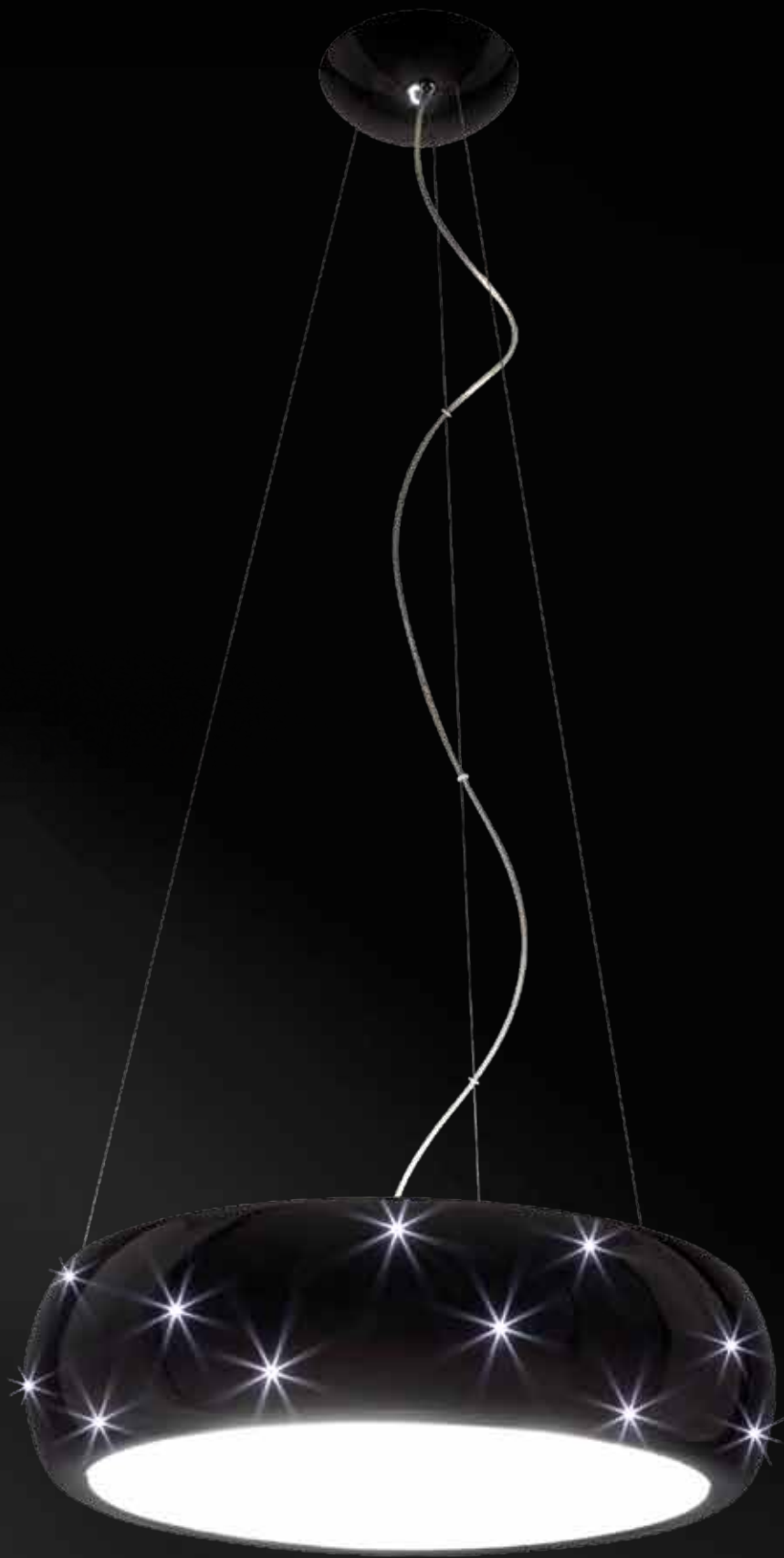



diAMANTE

Design Roberto Favaretto

LED
SMD



Il design moderno è dominato da linee e spigoli, una concentrazione di forme geometriche essenziali. Ecco l'interpretazione di Favaretto di questa tendenza, ampiamente applicata ai nuovi stili d'arredamento: figure geometriche che si mescolano a tagli di luce, spigoli e linee perfettamente iscritte in un cerchio! Disponibile in finitura Bianco o Nero.

Modern design given by essential geometrical lines. This is Roberto Favaretto's way of interpreting the latest trends, fully applied to the new furnishings styles: geometrical shapes mixed with light cuts, sharp corners and spatial lines forming a circle! Available in a choice of white or black painted.

diAMANTE PT

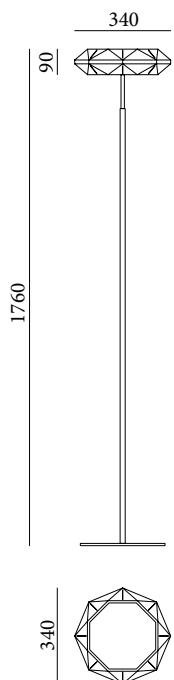

Materiali/Materials:
Metallo bianco o nero. Diffusore in vetro.
White or black metal. Glass diffuser.

Elettrificazione /Electrics:
1xR7s 150W 78mm



M151.07

M151.08



Colore/Color:
Bianco
White

Colore/Color:
Nero
Black

diAMANTE SO

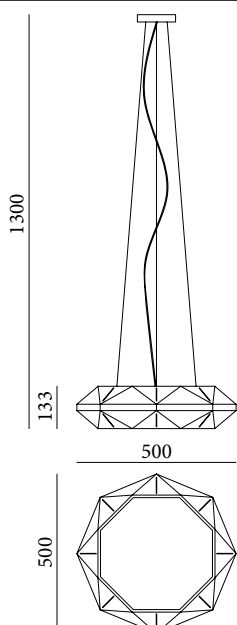

Materiali/Materials:
Metallo bianco o nero. Diffusore in vetro.
White or black metal. Glass diffuser.

Elettrificazione /Electrics:
4xE27 42W (or 15W e.s. 
4xE27 + 18xLed 1W



M151.01

M151.02

M151.03

M151.04



E27
Colore/Color:
Bianco
White

E27+LED
Colore/Color:
Bianco
White

E27
Colore/Color:
Nero
Black

E27+LED
Colore/Color:
Nero
Black



diAMANTE TA

M151.05

M151.06

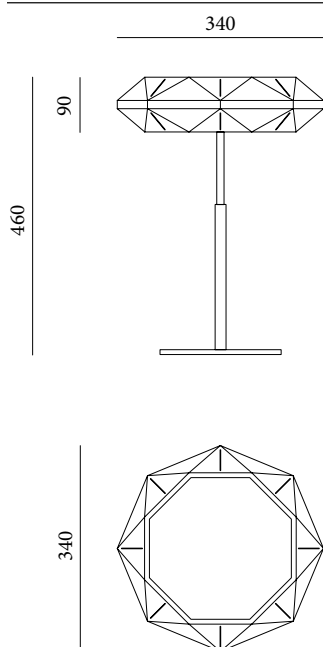

Materiali/Materials:
Metallo bianco o nero. Diffusore in vetro.
White or black metal. Glass diffuser.

Elettrificazione /Electrics:
1xR7s 100W 78mm



Colore/Color:
Bianco
White



Colore/Color:
Nero
Nero

diAMANTE AP

M151.09

M151.10

M151.11

M151.12

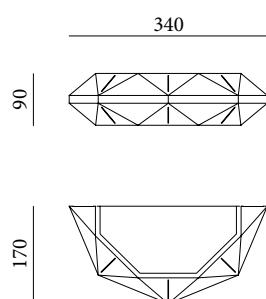

Materiali/Materials:
Metallo bianco o nero. Diffusore in vetro.
White or black metal. Glass diffuser.

Elettrificazione /Electrics:
1x2G11 18W
1x2G11 18W + Led IW



2G11
Colore/Color:
Bianco
White



2G11+LED
Colore/Color:
Bianco
White



2G11
Colore/Color:
Nero
Black



2G11+LED
Colore/Color:
Nero
Black

diAMANTE PT

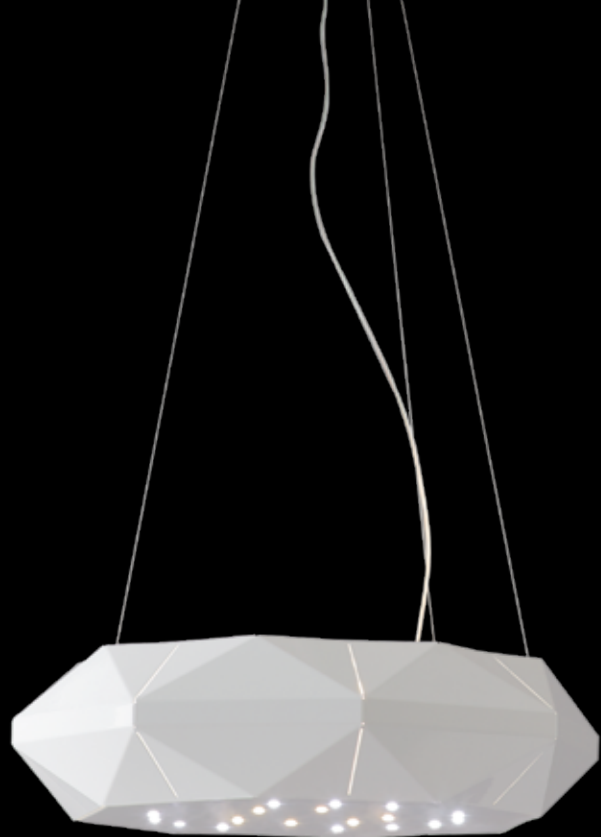

diAMANTE SO

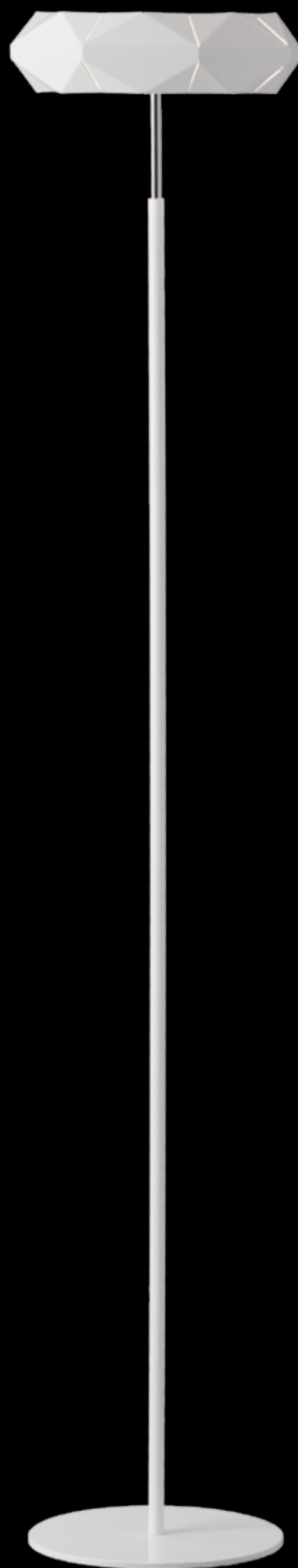



diAMANTE TA



diAMANTE AP





MAYA

Design Pamio Design

LED
SMD



Raffinatezza stilistica e dettagli sofisticati: il progetto parte da presupposti stilistici già codificati che hanno portato all'elaborazione, da parte di PamioDesign, di questa nuova lampada per ambienti contemporanei dalla forma compatta ed elegante. Diffusore in vetro soffiato opale, molato a mano.

Disponibile in finitura Bianco e Nickel Spazzolato, 1xE27 o 1xLED RGB fullcolor.

Stylish design and sophisticated details: the guiding principles behind this project are based on the great experience of the Designers, PamioDesign, who have designed this compact yet elegant luminaire for interior residential use. Hand-grinded etched opal blown glass diffuser.

Available in a choice of white painted and brushed nickel. Light source 1xE27 or 1xLED RGB fullcolor.

MAYA PT

M150.04

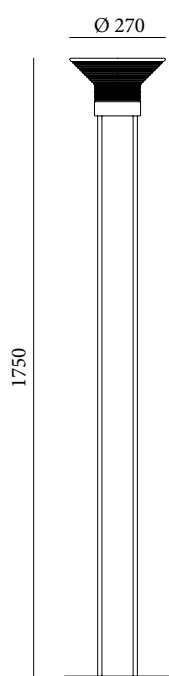

Materiali/Materials:

Diffusore in vetro soffiato. Struttura in metallo verniciato.
Blown glass diffuser. Metal painted frame.

Elettrificazione /Electrics:

1xE27 42W (or 15W e.s.) 



Colore/Color:
Bianco
White

MAYA SO

M150.03

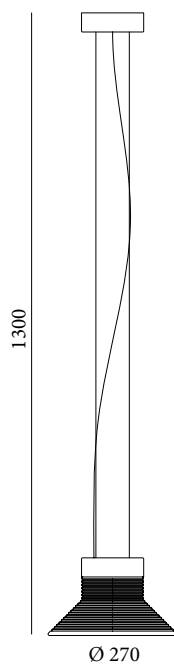

Materiali/Materials:

Diffusore in vetro soffiato. Struttura in metallo verniciato.
Blown glass diffuser. Metal painted frame.

Elettrificazione /Electrics:

1xE27 42W (or 15W e.s.) 



Colore/Color:
Bianco
White

MAYA TA

M150.05

M150.06

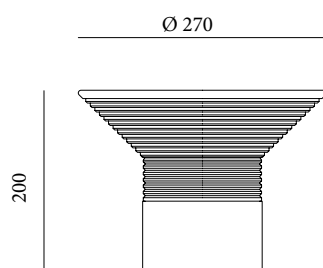

Materiali/Materials:

Diffusore in vetro soffiato. Struttura in metallo verniciato.
Blown glass diffuser. Metal painted frame.

Elettrificazione/Electrics:

1xE27 42W (or 15W e.s. 
1xLED RGB fullcolor



E27

Colore/Color:
Bianco
White

RGB

Colore/Color:
Bianco
White

MAYA AP

M150.01

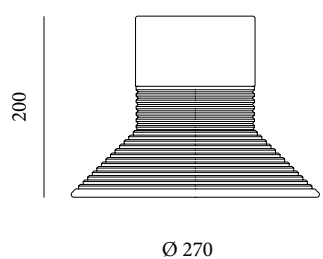

Materiali/Materials:

Diffusore in vetro soffiato. Struttura in metallo verniciato.
Blown glass diffuser. Metal painted frame.

Elettrificazione/Electrics:

1xE27 42W (or 15W e.s. 



E27

Colore/Color:
Bianco
White



Con le versioni RGB, la lampada diventa un oggetto d'arredo per una illuminazione diffusa emozionale o di cortesia. Controllata da un radiocomando, può emettere luce colorata fissa o a ciclo continuo.

Used in a RGB version, Maya becomes a highly emotional lamp; controlled by a remote controller, it can continuously change colours or stay fix in one.







310





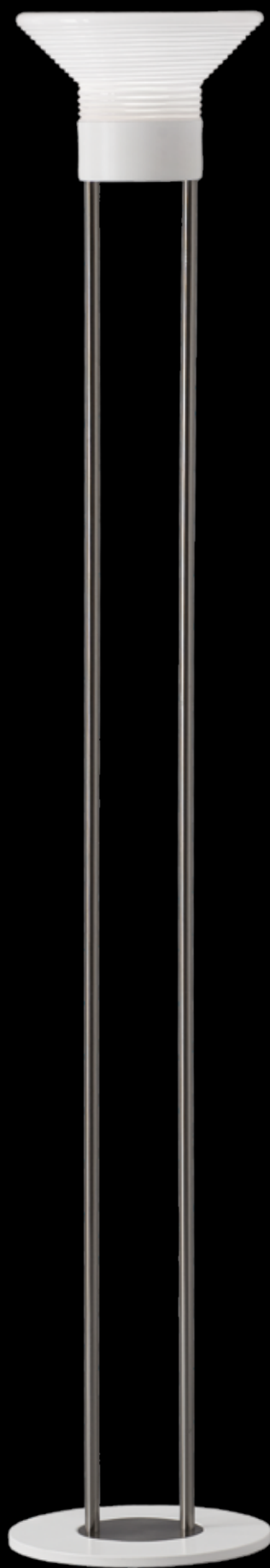

MAYA PT

SHOWER LIGHT

Design Giulio Iacchetti

LED
SMD



Shower-Light è una dislocazione di senso. Una doccia che si sposta, che cambia significato, che si fa lampada. Un'assurdità? A quanto pare no, perché l'oggetto ha l'essenzialità di un'eleganza sofisticata e la linea precisa di una forma progettata. Per diventare un nuovo simbolo.

Shower-Light is a revolutionary concept which goes beyond the traditional idea of light. A shower which becomes a luminaire providing amusement and fun. Something totally different from what you would normally expect from a lamp? Not at all, because sophisticated elegance and rigorous lines are crucial factors. To become a new symbol.

SHOWER LIGHT PT

M148.01

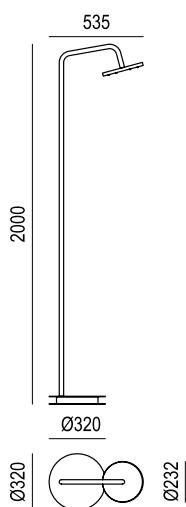

Materiali/Materials:
Metallo cromato
Chrome metal

Elettrificazione /Electrics:
18xLed 1W
n° 6 Led Luce Calda/Warm Light Led
n° 12 Led Luce Fredda /Cold Light Led



Colore/Color:
Cromo
Chrome

SHOWER LIGHT AP

M148.07

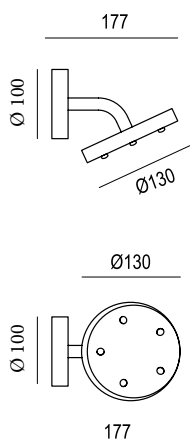

Materiali/Materials:
Metallo cromato
Chrome metal

Elettrificazione /Electrics:
5xLed 1W



Colore/Color:
Cromo
Chrome

SHOWER LIGHT SO

M148.03

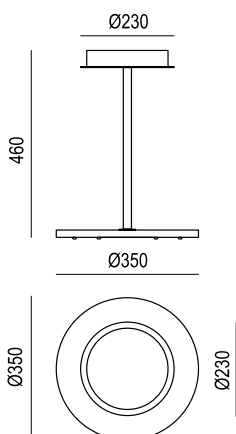

Materiali/Materials:
Metallo cromato
Chrome metal

Elettrificazione /Electrics:
24xLed 1W
n° 8 Led Luce Calda/Warm Light Led
n° 16 Led Luce Fredda /Cold Light Led



Colore/Color:
Cromo
Chrome



SHOWER LIGHT PT

SHOWER LIGHT AP



6 x LED 1 Watt



12 x LED 1 Watt



18 x LED 1 Watt

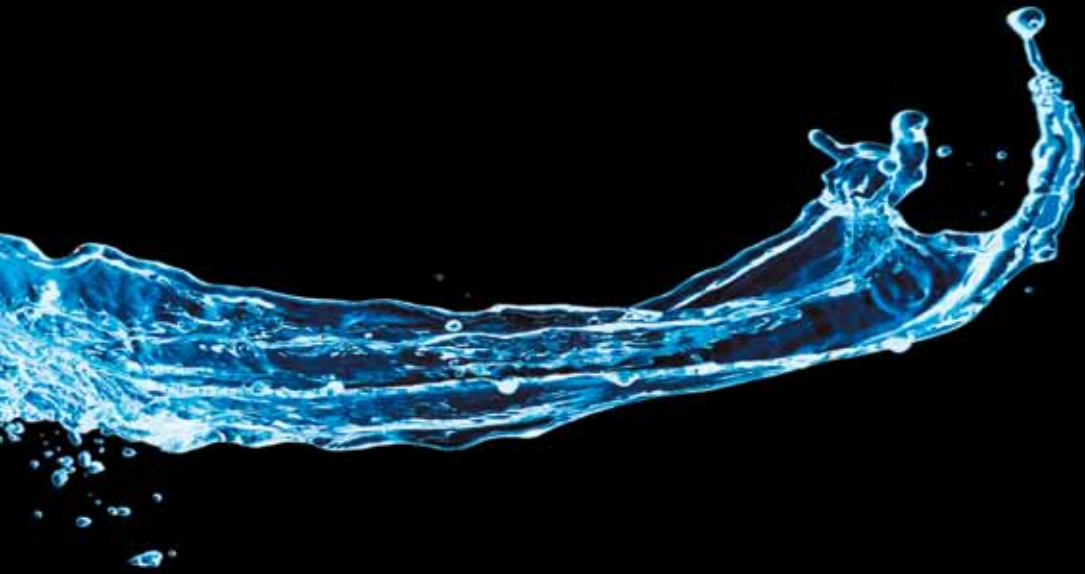



Il cavo, della lunghezza di 3 metri,
si avvolge sulla base.

A three meter winded round the base.

La lampada è dotata di interruttore
elettronico "a tocco" per la selezione delle
diverse soluzioni luminose.

*The luminaire is switched on electronically by lightly
touching the button. In addition it gives minimal
consumption and reduced maintenance.*

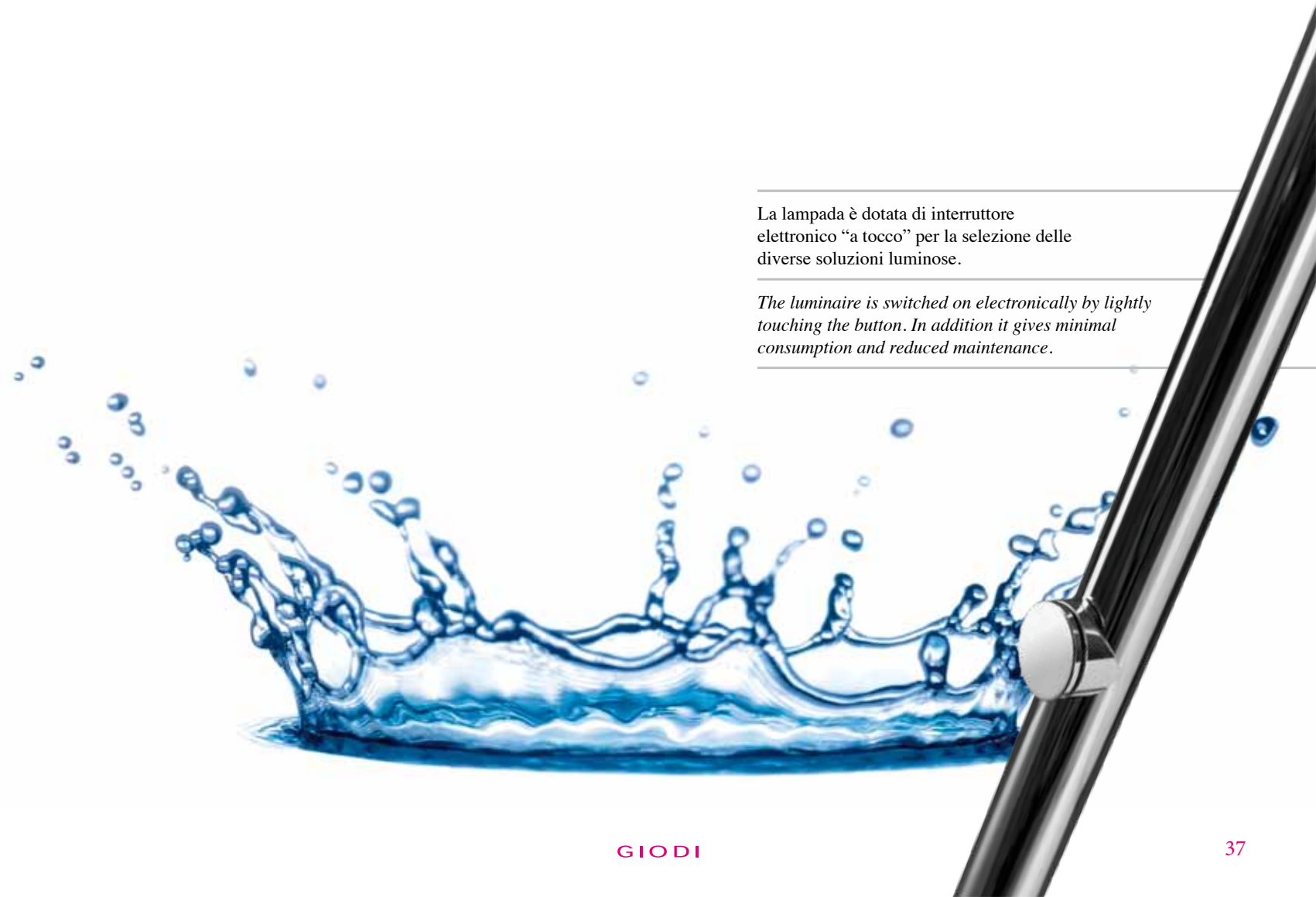

MICRO

Design Odoardo Fioravanti

LED
SMD



Se il LED è una piccolissima lampadina perché non pensare a una piccolissima lampada da costruire intorno ad esso? Na-sce così la Micro alta come un accendino, grande quanto una mela. È una piccola-grande lampada che racconta un cambio improvviso di scala e di percezione.

Materiali: base in pressofusione d'alluminio, diffusore in metacrilato bianco, elemento ottico interno diffondente in policarbonato satinato. Alimentatore elettronico a spina.

La piccola Grande lampada: progettata per un facile smaltimento: a fine vita del prodotto, ciascun elemento è facilmente separabile per un corretto smaltimento.

If LED is a very small light source, why not create a very small lamp around it? Micro comes out as a result of this premise, not higher than a lighter, as big as an apple. It is a small-big lamp witnessing a sudden change in scale and perception.

Die-cast aluminium base, diffuser in white methacrylate. Designed for easy dismantling: at end of product life, each element is easy to be separated for easy dismantling.

M145.01

M145.02

M145.03

M145.04

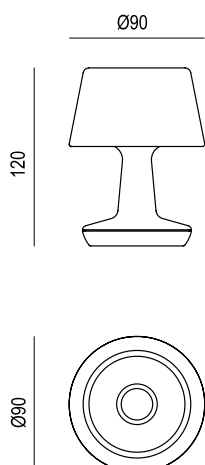

Materiali / Materials:
Base in metallo
Metal base
Diffusore in metacrilato
Methacrylate diffuser

Elettrificazione / Electrics:
1xLed 1W



Colore/ Color:
Base Cromo
Chrome base
Diffusore bianco
White diffuser



Colore/Color:
Base Fucsia
Pink base
Diffusore bianco
White diffuser



Colore/ Color:
Base Verde acido
Acid Green base
Diffusore bianco
White diffuser



Colore/ Color:
Base Azzurra
Sky blue base
Diffusore bianco
White diffuser

* alimentatore elettronico a spina / electronic driver plug







TÊTE A TÊTE

Design Joe Velluto

LED
SMD



Una cena a lume di candela, l'abito più bello e sensuale, il momento più atteso fievolmente illuminato dalla luce filtrata dalla maliziosità dell'organza nera, tra un sedile dell'auto e il freno a mano.

Tête à tête è una lampada versatile, e può essere collocata ovunque poiché dotata di gancio e presa di alimentazione da 12V per l'accendisigari da macchina.

Quando si possiede la comodità delle mura domestiche, può trovare spazio in casa grazie ad un supporto che la trasforma in lampada da tavolo.

A candlelit dinner, a sensual and extravagant dress, the most awaited moment with the light slightly filtering through a malicious black organdie lampshade between the car seat and the handbrake.

Tête à tête is a versatile and functional luminaire, whose light head can be moved and placed anywhere

thanks to a metal hook and to the 12V supply suitable for car lighters. Yet, it can find proper place in a comfortable house thanks to a device transforming it into a table lamp.

TÊTE À TÊTE CL

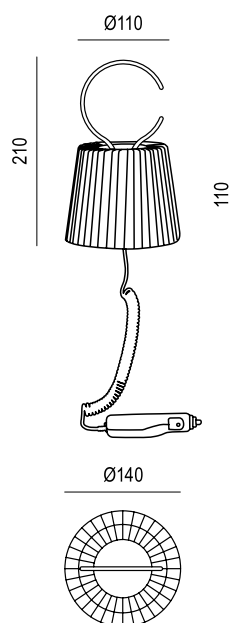

Materiali/Materials:

Gancio in metallo
Metal hook

Paralume in organza
Organdie lampshade

Elettrificazione /Electrics:
3xLed 1W



M149.01



Colore/Color:
Gancio cromo
Chrome hook
Paralume Nero
Black lampshade
Luce bianca
White light

M149.02



Colore/Color:
Gancio cromo
Chrome hook
Paralume bianco
White lampshade
Luce bianca
White light

M149.03



Colore/Color:
Gancio cromo
Chrome hook
Paralume bianco
White lampshade
Luce blu
Blue light

M149.04



Colore/Color:
Gancio cromo
Chrome hook
Paralume bianco
White lampshade
Luce rossa
Red light

TÊTE À TÊTE LT

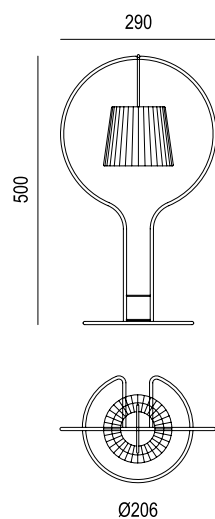

Materiali/Materials:

Montatura e gancio in metallo
Metal frame and metal hook

Paralume in organza
Organdie lampshade

Elettrificazione /Electrics:
3xLed 1W



M149.05



Colore/Color:
Montatura e
gancio cromo
Chrome frame
and chrome hook
Paralume Nero
Black lampshade
Luce bianca
White light

M149.06



Colore/Color:
Montatura e
gancio cromo
Chrome frame
and chrome hook
Paralume bianco
White lampshade
Luce bianca
White light



TÊTE A TÊTE TA

TÊTE À TÊTE AP

M149.07

M149.08

M149.09

M149.10

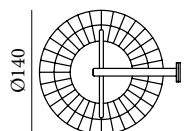
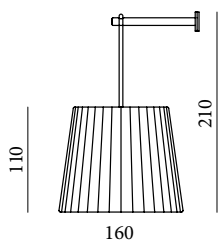

Materiali/Materials:

Montatura e gancio in metallo
Metal frame and metal hook

Paralume in organza
Organdie lampshade

Elettrificazione /Electrics:
3xLed 1W



Colore/Color:
Montatura e
gancio cromo
Chrome frame
and chrome hook

Paralume Nero
Black lampshade

Luce bianca
White light

Colore/Color:
Montatura e
gancio cromo
Chrome frame
and chrome hook

Paralume bianco
White lampshade

Luce bianca
White light

Colore/Color:
Montatura e
gancio cromo
Chrome frame
and chrome hook

Paralume bianco
White lampshade

Luce blu
Blu light

Colore/Color:
Montatura e
gancio cromo
Chrome frame
and chrome hook

Paralume bianco
White lampshade

Luce rossa
Red light

TÊTE A TÊTE CL





TÊTE A TÊTE AP



La lampada "mobile":

*Struttura portante e gancio in metallo cromato,
elemento illuminante con 3 Led da 1W
di cui 1 verso l'alto e due verso il basso;
diffusore con doppia struttura interna del paralume
finemente rivestita in organza bianca o nera.
Alimentatore elettronico a spina.
Disponibile anche con presa 12V per autovettura.*

*A versatile and functional lamp,
whose light head can be moved and placed anywhere
thanks to a metal hook and
to the 12V supply suitable for car lighters.
Tête à Tête is equipped with 3 power Leds 1W each,
giving filtered light through the white or black
organza lampshade.
Micro driver placed in the plug.*

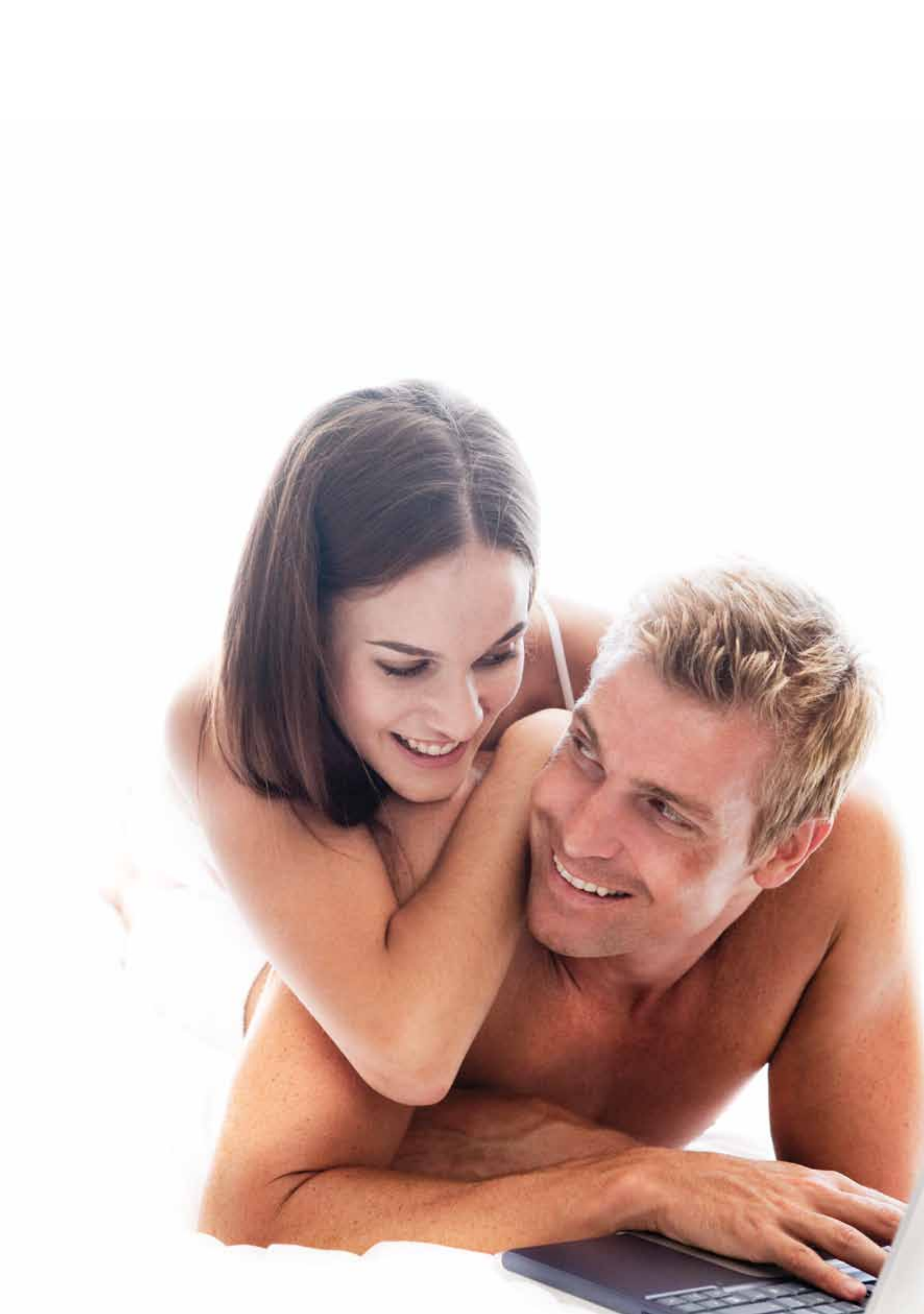





TWISTER

Design Ufficio Tecnico

Serie di lampade a luce diffusa da parete, soffitto, terra e sospensione. Il corpo lampada è realizzato da anelli di metallo curvato attraverso i quali filtra una parte di luce creando un'atmosfera soffusa lungo le pareti delle lampade. Finitura verniciato bianco RAL 9010, su richiesta foglia oro. Disponibile anche con illuminazione a LED SMD multi-chip a luce bianca calda. Su richiesta sono disponibili kit per luce colorata nelle versioni rosso o blu.

Collection of lamps giving diffuse lighting, available as wall, ceiling, floor and pendant. The body is made of bent metal rings, letting light filter through to create a soft and pleasant atmosphere. Available in white painted RAL 9010, on request with 24K gold foil. The luminaire can be also electrified with multichip LED SMD in warm white. On request red and blue accessories are available to give coloured light.

Kollektion von Wand-, Decken-, Stand- und Hängeleuchten mit diffuser Lichtverteilung. Struktur aus gebogenen Metallringen, welche eine ganz besondere und gemütliche Atmosphäre schaffen lassen. Verfügbar in weiß lackiert RAL 9010 oder auf Anfrage in blattgold 24K. Die Leuchten sind auch mit LED SMD multichip – warmweiß – erhältlich. Auf Anfrage Farbfilter in rot und blau lieferbar.

Collection de lampes disponibles en applique, plafonnier, lampadaire et suspension pour éclairage diffuse. La structure est caractérisée par des anneaux en métal plié, qui laissent filtrer la lumière en créant une atmosphère agréable. Disponible en vernisé blanc RAL 9010 et, sur demande, en feuille d'or 24K. Disponible aussi dans la version avec LED SMD multichip, blanc chaud. Sur demande on peut fournir de filtres de couleur rouge ou bleu.

Serie de luminarias de luz difusa de pared, techo, pié y suspensión. Estructura de anillos en metal plegado que crean una atmosfera cálida y agradable. Disponible en acabado pintado blanco RAL 9010 y con baño de oro 24K. Disponible tambien con LED SMD multichip en blanco cálido. A pedido filtros colorados en rojo y azul por crear efectos de luz atractiva.



sidelight rosso



sidelight blu



Bianco

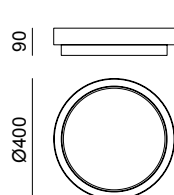

KIT sidelight PL40	
colore	codice
rosso ●	396011
blu ●	396012

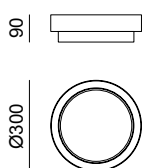

KIT sidelight PL30	
colore	codice
rosso ●	396021
blu ●	396022

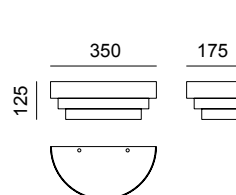

KIT sidelight AP35	
colore	codice
rosso ●	396031
blu ●	396032

elettrificazione	finitura	codice
3xE27 28W	bianco	G1823.02
1xLED SMD 15W 3000Kb	ianco	G1823.12

IP 20

elettrificazione	finitura	codice
2xE27 28W	bianco	G1823.03
1xLED SMD 9W 3000Kb	ianco	G1823.13

IP 20

elettrificazione	finitura	codice
1xE27 42W	bianco	G1823.04
LED SMD 11W 3000Kb	ianco	G1823.14

IP 20

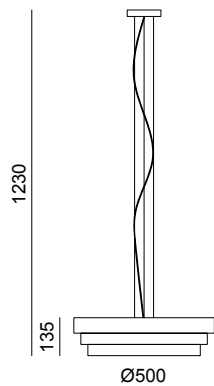

KIT sidelight SO50	
colore	codice
rosso ●	396001
blu ●	396002

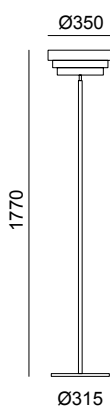

KIT sidelight TR35	
colore	codice
rosso ●	396051
blu ●	396052

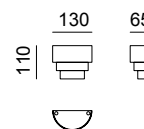

elettrificazione	finitura	codice
3xE27 42W	bianco	G1823.01
1xLED SMD 19W 3000Kb	ianco	G1823.11

IP 20

elettrificazione	finitura	codice
1xE27 105W	bianco	G1823.06

IP 20

elettrificazione	finitura	codice
1xG9 42W	bianco	G1823.05
LED SMD 2.2W 3000Kb	ianco	G1823.15

IP 20

G1823.04

G1823.06



Corpo lampada in metallo infrangibile e facile da pulire, ideale per l'inserimento in contesti quali il contract o grandi forniture.

Body made of unbreakable metal, easy to clean, with a sober yet elegant design that makes it ideal for use in the contract market, without sacrificing style for function.



G1823.01

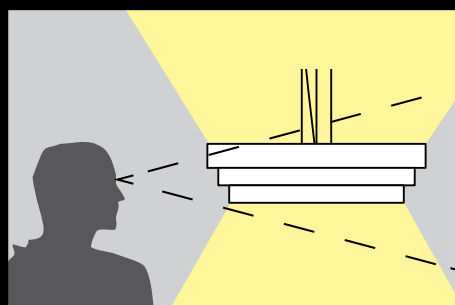

La posizione degli anelli è studiata per evitar aperture superiore ed inferiore consentono un notevole flusso luminoso per l'illuminazione generale.

The position of the rings has been duly designed in order to avoid any side dazzling, while the upper and lower openings create a diffuse general lighting.

GASTONE

Design Roberto Favaretto

Lampada da tavolo a luce diretta. Il corpo è realizzato con un unico elemento di metallo tagliato e piegato. Finitura verniciato bianco RAL 9010. L'illuminazione è data da una scheda LED SMD multi-chip a luce bianca calda, diffusore in PMMA trasparente oppure colorato blu o rosso su richiesta. Alimentatore elettronico incluso.

Table lamp designed for your everyday life, offering maximum visual comfort and modern design. The structure is in laser cut bent metal, available in white RAL 9010. A choice of pmma diffusers (transparent, red or blue) is available on request. Equipped with multichip LED SMD in warm white. Built in electronic ballast.

Tischleuchte mit direkter Lichtverteilung. Struktur aus gebogenem Metall Lasercut, lieferbar in weiß RAL 9010. Bestückung LED SMD multichip – warmweiß – Driver intern. Auf Anfrage sind Diffusoren aus PMMA in transparent, rot oder blau lieferbar.

Lampe de table pour éclairage directe. Structure en métal coupé à laser et plié, disponible en blanc RAL 9010. Equipé avec LED SMD multichip – blanc chaud - avec ballast intégré. Sur demande une gamme de diffuseurs en pmma est disponible (transparent, rouge ou bleu).

Lámpara de mesa de luz directa. Estructura en metal realizado con tecnología láser y plegado, disponible en acabado blanco RAL 9010. Fuente de luz: LED SMD multichip con alimentador incorporado. A pedido difusores en PMMA disponibles en transparente, rojo y azul por crear efectos de luz decorativa.

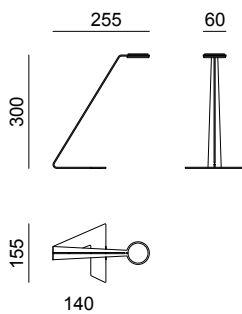

elettrificazione	anello	finitura	codice
1xLED SMD 2.9W 3000K	trasparente	bianco	G1824.01
1xLED SMD 2.9W 3000K	rosso	bianco	G1824.02
1xLED SMD 2.9W 3000K	blu	bianco	G1824.03

IP 20

LED SMD

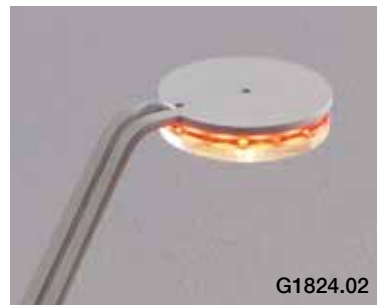

Bianco



G1824.01

PIPER

Design Ufficio Tecnico



Una linea minimalista e decisa caratterizza questa sospensione adatta per l'illuminazione d'accento. La struttura è in metallo disponibile nelle finiture bianco, nero e foglia oro. L'illuminazione è data da LED di potenza da 1.2W con ottica integrata, alimentatore elettronico incorporato. Estremamente versatile, Piper si adatta perfettamente all'illuminazione di grandi spazi, creando geometrie particolari e forme suggestive.

Stylish pendant characterized by clean and essential design giving accent lighting. Made of metal, available in white, black and 24K gold foil. Equipped with 1.2W power led with built in electronic ballast. Its sobre and minimalist design allows you to create a volume of very light light pendants, perfectly adapting to a wide space.

Klare Linien und funktionelles Design für diese Hängeleuchte mit direkter Lichtverteilung. Körper aus Metall, lieferbar in weiß, schwarz und blattgold 24K. Bestückung Power Led 1.2W, Driver intern. Dank seinem vielseitigen Design ist Piper geeignet auch für die Beleuchtung großer Räumen.

Suspension à Led caractérisée par un design sobre et minimaliste pour éclairage d'accent. Structure en métal disponible dans la finition blanc, noir et en feuille d'or 24K. Équipé avec Led de puissance 1.2W avec ballast intégré. Piper peut bien s'adapter à de grands espaces, en créant un grand volume de suspensions ensemble.

Diseño sobrio y minimalista por Piper, lámpara colgante en metal, disponible en acabado blanco, negro y con baño de oro 24K. Fuente de luz: led de potencia 1.2W con alimentador incorporado. Muy versátil, mediante su repetición te permitirá crear ambientes sugestivos y atractivos.



Bianco

Nero opaco

Oro



Ø32

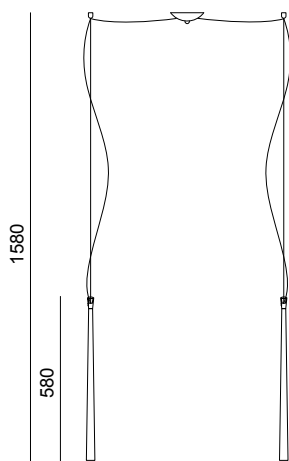

Ø32

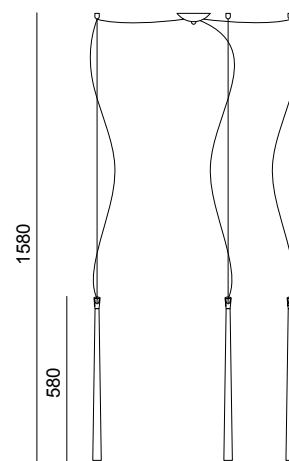

Ø32

elettrificazione	finitura codice
1xLED 1.2W 350mA - 3500K bianco	G1822.01
1xLED 1.2W 350mA - 3500K nero	G1822.11
1xLED 1.2W 350mA - 3500K oro	G1822.21
1xLED 2.4W 700mA - 3500K bianco	G1822.31
1xLED 2.4W 700mA - 3500K nero	G1822.41
1xLED 2.4W 700mA - 3500K oro	G1822.51



elettrificazione	finitura codice
2xLED 1.2W 350mA - 3500K bianco	G1822.02
2xLED 1.2W 350mA - 3500K nero	G1822.12
2xLED 1.2W 350mA - 3500K oro	G1822.22
2xLED 2.4W 700mA - 3500K bianco	G1822.32
2xLED 2.4W 700mA - 3500K nero	G1822.42
2xLED 2.4W 700mA - 3500K oro	G1822.52

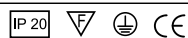

elettrificazione	finitura codice
3xLED 1.2W 350mA - 3500K bianco	G1822.03
3xLED 1.2W 350mA - 3500K nero	G1822.13
3xLED 1.2W 350mA - 3500K oro	G1822.23
3xLED 2.4W 700mA - 3500K bianco	G1822.33
3xLED 2.4W 700mA - 3500K nero	G1822.43
3xLED 2.4W 700mA - 3500K oro	G1822.53

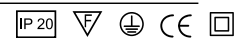

G1822.01



MILLY

Design Roberto Favaretto

LED
SMD



Serie di lampade a luce mista (diffusa sopra e diretta sotto) da parete, tavolo, terra e sospensione. Il riflettore è realizzato in metallo piegato che dà vita ad un elegante gioco di luci vedo-non-vedo, disponibile verniciato bianco o con applicazione di foglia oro 24K. Disponibile anche con illuminazione a LED SMD multi-chip a luce bianca naturale.

Modern collection of lamps including wall, table, floor and pendant versions giving mixed lighting (diffuse upwards and direct downwards). The reflector is in laser cut and bent metal, letting light filter through in a soft yet playful way. Available in white painted or with 24K gold foil. Also available with multi-chip SMD LED natural white light.

Kollektion von Hänge-, Wand-, Tisch- und Standleuchten für diffuse Lichtverteilung nach oben und direkte Lichtverteilung nach unten. Reflektor aus gebogenem und Lasercut Metall, verfügbar in weiß lackiert oder blattgold 24K. Die kleinen Schlitz ziehen die Blicke an und durch sie dringt das Licht auf die diskrete Art ein. Die Leuchte ist auch mit LED SMD multi-chip erhältlich, naturweiß.

Collection de lampes disponible en applique, table, lampadaire et suspension pour éclairage diffuse au dessus et directe vers le bas. Le réflecteur est en métal coupé laser et plié, disponible dans la finition vernisé blanc ou en feuille d'or 24K. Les petites fentes laissent filtrer la lumière dans une façon délicate et élégante. Le produit est aussi disponible dans la version avec LED SMD multi-chip, lumière blanche naturelle.

Serie de luminarias de luz difusa y directa de pared, mesa, pié, y suspensión. Reflector en metal realizado con tecnología láser y plegado para darle una forma simple pero al mismo tiempo elegante. Disponible en pintado blanco y con baño de oro 24K. Disponible tambien con LED SMD multi-chip a luz blanca natural.



Bianco



Foglia Oro

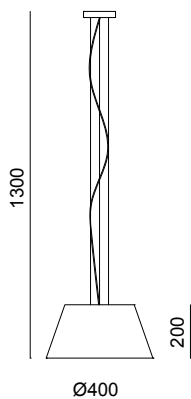
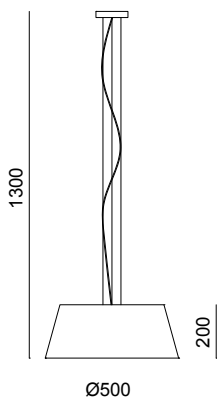

elettrificazione	finitura	codice
3xE27 42W	Bianco	G1814.01
3xE27 42W	Foglia Oro	G1814.02
1xLED SMD 19W 4500K	Bianco	G1814.11
1xLED SMD 19W 4500K	Foglia Oro	G1814.12

IP 20

elettrificazione	finitura	codice
1xE27 70W	Bianco	G1814.03
1xE27 70W	Foglia Oro	G1814.04
1xLED SMD 15W 4500K	Bianco	G1814.13
1xLED SMD 15W 4500K	Foglia Oro	G1814.14

IP 20

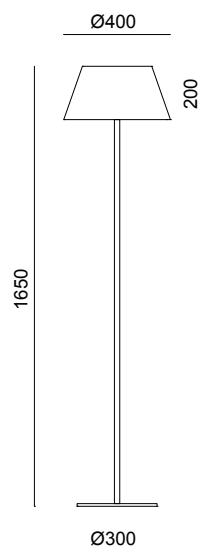
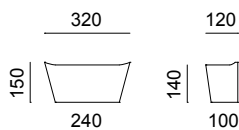
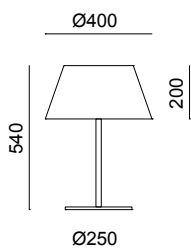

elettrificazione	finitura	codice
2xE27 42W	Bianco	G1814.07
2xE27 42W	Foglia Oro	G1814.08
1xLED SMD 15W 4500K	Bianco	G1814.17
1xLED SMD 15W 4500K	Foglia Oro	G1814.18

IP 20

elettrificazione	finitura	codice
1xE27 42W	Bianco	G1814.09
1xE27 42W	Foglia Oro	G1814.10
LED SMD 11W 4500K	Bianco	G1814.19
LED SMD 11W 4500K	Foglia Oro	G1814.20

IP 20

elettrificazione	finitura	codice
2xE27 52W	Bianco	G1814.05
2xE27 52W	Foglia Oro	G1814.06
1xLED SMD 15W 4500K	Bianco	G1814.15
1xLED SMD 15W 4500K	Foglia Oro	G1814.16

IP 20





G1814.05



G1814.01



G1814.08





G1814.10



FRISBEE

Design Roberto Favaretto

LED
SMD



Serie di lampade a soffitto, parete o sospensione per illuminazione diffusa. La struttura è in metallo cromato e verniciato bianco, diffusore in vetro satinato. L'illuminazione è data da due circoline T5 (40W+22W) o da moduli a LED SMD multichip, alimentatore elettronico incorporato.

Collection of ceiling and pendant luminaires giving diffuse lighting. Metal body available in chrome or white painted, satin glass diffuser. For use with 2 circular fluorescent lamps or with LED SMD multichip with integrated electronic ballast.

Kollektion von Decken- und Hängeleuchten mit modernem Design für diffuse Lichtverteilung. Metallarmatur verchromt oder weiß lackiert, Diffusor aus Glas satiniert. Bestückung 2xKreisröhren T5 oder LED SMD multichip, Driver intern.

Collection de plafonniers et suspensions pour éclairage diffuse. Structure en métal chromé ou vernisée blanc, diffuseur en verre satiné. Pour lampes T5 fluorescentes circulaires ou équipée avec LED SMD multichip, transformateur électronique intégré.

Serie de lámparas de techo y colgante de luz difusa. Estructura en metal acabado cromado ó pintado blanco, difusor en cristal satinado. La iluminación la facilitan dos tubos fluorescentes circulares T5 ó LED SMD multi chip con alimentador electrónico incorporado.

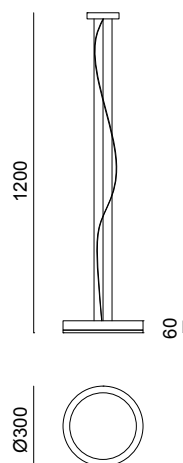
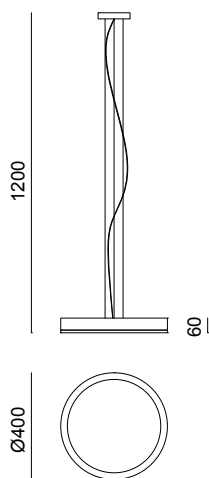
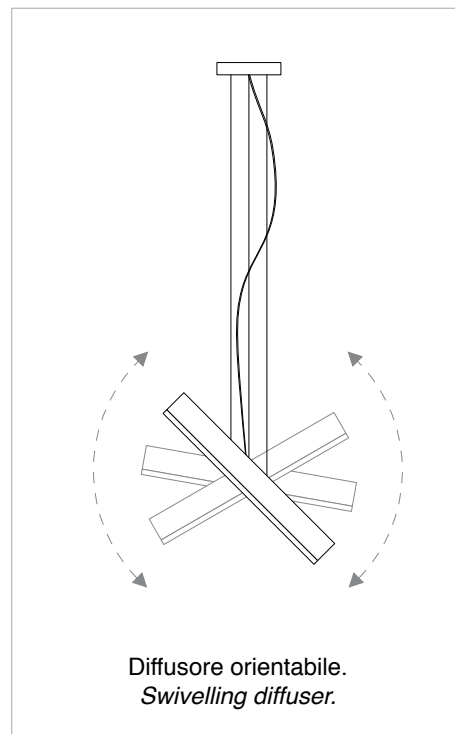

elettrificazione	finitura	codice
1x2GX13 40W + 1x2GX13 22W	○ Bianco + Cromo	G1818.01
1xLED SMD 19W 4500K	○ Bianco + Cromo	G1818.02

IP 20

elettrificazione	finitura	codice
1x2GX13 22W	○ Bianco + Cromo	G1818.03
1xLED SMD 15W 4500K	○ Bianco + Cromo	G1818.04

IP 20

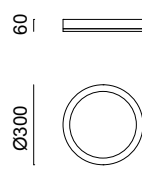
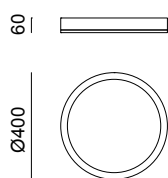

elettrificazione	finitura	codice
1x2GX13 40W + 1x2GX13 22W	○ Bianco + Cromo	G1818.05
1xLED SMD 19W 4500K	○ Bianco + Cromo	G1818.06

IP 20

elettrificazione	finitura	codice
1x2GX13 22W	○ Bianco + Cromo	G1818.07
1xLED SMD 15W 4500K	○ Bianco + Cromo	G1818.08

IP 20



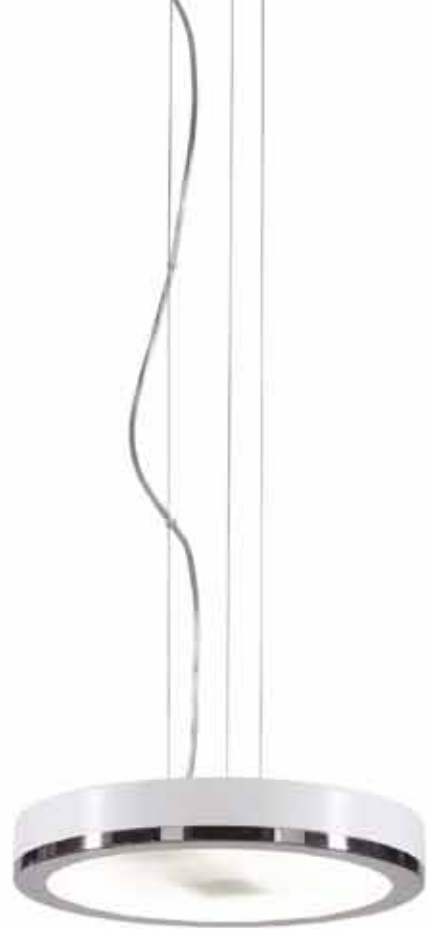



G1818.05

G1818.07

STYLO

Design Roberto Favaretto

LED
SMD



Serie di lampade a bi-emissione con diffusore in vetro extra chiaro satinato. Struttura in metallo. Disponibile nelle versioni a sospensione, parete, soffitto, tavolo e terra. Disponibile anche con illuminazione a LED SMD multi-chip a luce bianca naturale.

Range of pendant, wall, ceiling, table and floor luminaires with bi-emission of light. Metal body, available in white painted or in polished chrome with etched glass diffuser. Also available with multi-chip SMD LED natural white light.

Kollektion von 2flämmigen Hänge-, Wand-, Decken-, Tisch- und Standleuchten. Struktur aus Metall, weiß lackiert oder chrom glänzend, und satiniertes Glas. Die Leuchte ist auch mit LED SMD multi-chip erhältlich, weiß Tageslicht.

Collection de lampes (applique, suspension, plafonnier, lampe à poser et lampadaire) à double éclairage. Structure en métal, vernisé blanc ou chrome brillant, et diffuseur en verre satiné. Le produit est aussi disponible dans la version avec LED SMD multi-chip, lumière blanche naturelle.

Serie de luminarias con difusor de cristal extra-claro satinado. Estructura de metal. Disponible en versiones de suspensión, pared, techo, mesa y de pie. Disponible tambien con LED SMD multi-chip a luz blanca natural.



Bianco



Cromo

Modelli depositati / Patent pending

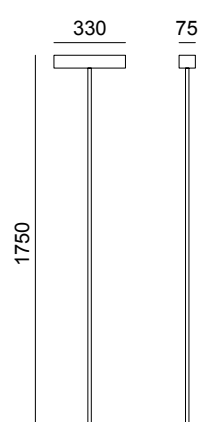
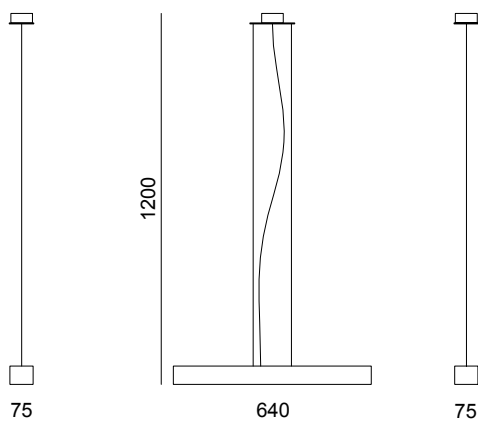
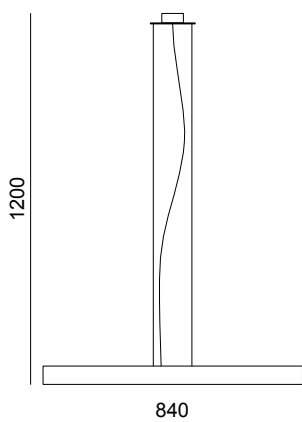

elettrificazione	finitura	codice
2x2G11 24W	Bianco	G1813.01
2x2G11 24W	Cromo	G1813.02
LED SMD 30.8W 4500K	Bianco	G1813.21
LED SMD 30.8W 4500K	Cromo	G1813.22

IP 20

elettrificazione	finitura	codice
2x2G11 18W	Bianco	G1813.03
2x2G11 18W	Cromo	G1813.04
LED SMD 22W 4500K	Bianco	G1813.23
LED SMD 22W 4500K	Cromo	G1813.24

IP 20

elettrificazione	finitura	codice
2xE27 100W	Bianco	G1813.15
2xE27 100W	Cromo	G1813.16

dimmer

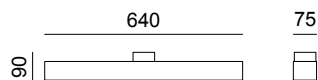
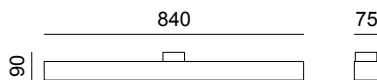

elettrificazione	finitura	codice
2x2G11 24W	Bianco	G1813.11
2x2G11 24W	Cromo	G1813.12
LED SMD 30.8W 4500K	Bianco	G1813.31
LED SMD 30.8W 4500K	Cromo	G1813.32

IP 20

elettrificazione	finitura	codice
2x2G11 18W	Bianco	G1813.13
2x2G11 18W	Cromo	G1813.14
LED SMD 22W 4500K	Bianco	G1813.33
LED SMD 22W 4500K	Cromo	G1813.34

IP 20

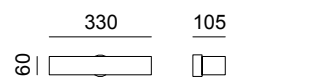
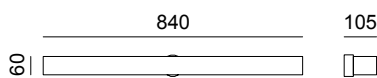

elettrificazione	finitura	codice
2x2G11 24W	Bianco	G1813.05
2x2G11 24W	Cromo	G1813.06
LED SMD 30.8W 4500K	Bianco	G1813.25
LED SMD 30.8W 4500K	Cromo	G1813.26

IP 20

elettrificazione	finitura	codice
2xE27 60W	Bianco	G1813.09
2xE27 60W	Cromo	G1813.10
LED SMD 8.8W 4500K	Bianco	G1813.29
LED SMD 8.8W 4500K	Cromo	G1813.30

IP 20

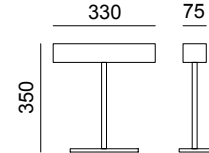

elettrificazione	finitura	codice
2xE27 60W	Bianco	G1813.17
2xE27 60W	Cromo	G1813.18

IP 20





G1813.18

G1813.16







G1813.12

G1813.10



G1813.09



MANHATTAN

Design Roberto Favaretto

LED
SMD





Serie di lampade a luce diffusa fluorescente o puntiforme a LED di cortesia. Accensione totale o separata delle fonti luminose. Struttura in metallo, diffusori vetro extra chiaro serigrafato per le versioni a sospensione e soffitto, con riflettore a specchio per la versione da parete e da terra. Disponibile anche con illuminazione a LED SMD multi-chip a luce bianca naturale.

Collection of luminaires giving diffuse light, using fluorescent and LED light sources. Independent switch to give general illumination or courtesy light. Body made of metal painted in white or silver, four silk-screen printed glasses (for pendant and ceiling models), mirror diffusers for wall and floor versions. Also available with multi-chip SMD LED natural white light.

Leuchten-Kollektion mit diffusem Licht dank der Fluor Lichtstreuung, auch mit LED Atmosphären-Licht. Vier extra klare und siebgedruckte Gläser für die Hänge- und Deckenleuchten; Spiegelreflektor für die Wand- und Standleuchte. Struktur aus Metall, weiß oder silber lackiert. Die Leuchte ist auch mit LED SMD multi-chip erhältlich, weiß Tageslicht.

Collection de lampes à lumière diffuse à source fluo avec une LED de puissance pour donner éclairage d'ambiance. Les versions en suspension et en plafonnier ont quatre lames de verre sérigraphié blanc, tandis que l'applique et le lampadaire ont un diffuseur à miroir. Structure en Métal vernisé blanc ou gris. Le produit est aussi disponible dans la version avec LED SMD multi-chip, lumière blanche naturelle.

Serie de luminarias de luz difusa fluorescente o puntiforme con LED de cortesia. Encendido total o separada por fuente luminosa. Estructura de metal, difusor de cristal extra-claro serigrafiado para la versión de suspensión y techo, con reflector espejo para la versión de pared y de pie. Disponible también con LED SMD multi-chip a luz blanca natural.

			
vetri glasses	3 bianco	2 bianco + 1 specchio	1 bianco + 2 specchio

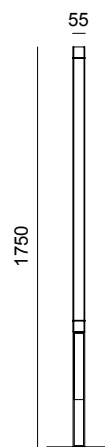

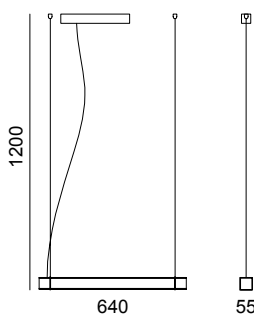

elettrificazione	finitura	codice
1xG5 54W + 1xLED 1W	Grigio	G1812.01
1xG5 54W + 1xLED 1W	Bianco	G1812.02

IP 20   



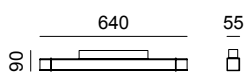

elettrificazione	finitura	codice
1xG5 24W	Cromo	G1812.06
1xG5 24W	Cromo	G1812.09
LED SMD 15.4W 4500K	Cromo	G1812.46
LED SMD 15.4W 4500K	Cromo	G1812.49

IP 20   



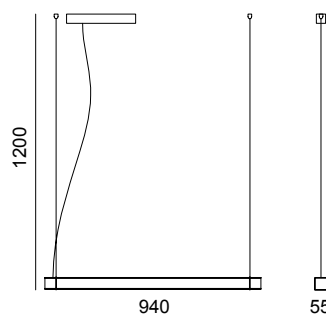

elettrificazione	finitura	codice
1xG5 24W	Cromo	G1812.03
1xG5 24W	Cromo	G1812.17
1xG5 24W	Cromo	G1812.14
LED SMD 15.4W 4500K	Cromo	G1812.43
LED SMD 15.4W 4500K	Cromo	G1812.57
LED SMD 15.4W 4500K	Cromo	G1812.54

IP 20   



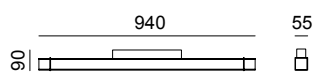

elettrificazione	finitura	codice
1xG5 39W	Cromo	G1812.07
1xG5 39W	Cromo	G1812.10
LED SMD 23.1W 4500K	Cromo	G1812.47
LED SMD 23.1W 4500K	Cromo	G1812.50

IP 20   



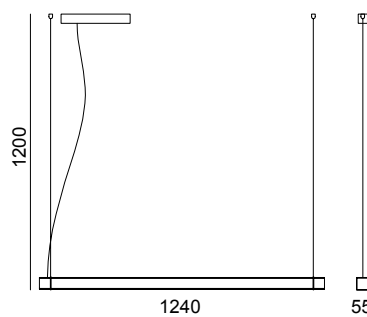

elettrificazione	finitura	codice
1xG5 39W	Cromo	G1812.04
1xG5 39W	Cromo	G1812.18
1xG5 39W	Cromo	G1812.15
LED SMD 23.1W 4500K	Cromo	G1812.44
LED SMD 23.1W 4500K	Cromo	G1812.58
LED SMD 23.1W 4500K	Cromo	G1812.55

IP 20   



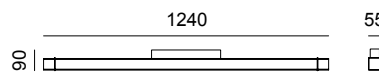

elettrificazione	finitura	codice
1xG5 54W	Cromo	G1812.08
1xG5 54W	Cromo	G1812.13
LED SMD 30.8W 4500K	Cromo	G1812.48
LED SMD 30.8W 4500K	Cromo	G1812.53

IP 20   



elettrificazione	finitura	codice
1xG5 54W	Cromo	G1812.05
1xG5 54W	Cromo	G1812.19
1xG5 54W	Cromo	G1812.16
LED SMD 30.8W 4500K	Cromo	G1812.45
LED SMD 30.8W 4500K	Cromo	G1812.59
LED SMD 30.8W 4500K	Cromo	G1812.56

IP 20   



G1812.02



G1812.04





G1812.15





Lampade da parete a luce indiretta, struttura in metallo verniciato o in foglia oro o argento. Disponibile anche con illuminazione a LED SMD multi-chip a luce bianca naturale.

Wall lamp giving indirect light, frame available in painted metal or with gold or silver foil. Also available with multi-chip SMD LED natural white light.

Wandleuchte mit indirektem Licht, Metall-Armatur lackiert oder mit Gold-, oder Silber-Folie. Die Leuchte ist auch mit LED SMD multi-chip erhältlich, weiß Tageslicht.

Applique à lumière indirecte, structure en métal vernisé ou avec feuille d'or ou argent. Le produit est aussi disponible dans la version avec LED SMD multi-chip, lumière blanche naturelle.

Lámpara de pared de luz indirecta, estructura de metal pintado ó con lámina de oro ó plata. Disponible tambien con LED SMD multi-chip a luz blanca natural.

Modelli depositati / Patent pending



Bianco



Grigio



Foglia Oro



Foglia Argento

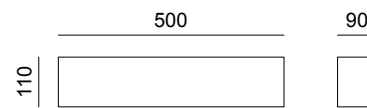
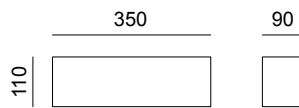
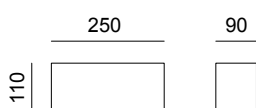

elettrificazione	finitura	codice
1xR7s 80W 78mm	Bianco	G1806.01
1xR7s 80W 78mm	Grigio	G1806.03
1xR7s 80W 78mm	Foglia Oro	G1806.04
1xR7s 80W 78mm	F. Argento	G1806.05
1xLED SMD 2.9W 4500K	Bianco	G1806.21
1xLED SMD 2.9W 4500K	Grigio	G1806.23
1xLED SMD 2.9W 4500K	Foglia Oro	G1806.24
1xLED SMD 2.9W 4500K	F. Argento	G1806.25



elettrificazione	finitura	codice
1xR7s 120W 118mm	Bianco	G1806.06
1xR7s 120W 118mm	Grigio	G1806.08
1xR7s 120W 118mm	Foglia Oro	G1806.09
1xR7s 120W 118mm	F. Argento	G1806.10
1xG24-q2 18W	Bianco	G1806.11
1xG24-q2 18W	Grigio	G1806.13
1xG24-q2 18W	Foglia Oro	G1806.14
1xG24-q2 18W	F. Argento	G1806.15
2xLED SMD 2.9W 4500K	Bianco	G1806.26
2xLED SMD 2.9W 4500K	Grigio	G1806.28
2xLED SMD 2.9W 4500K	Foglia Oro	G1806.29
2xLED SMD 2.9W 4500K	F. Argento	G1806.30



elettrificazione	finitura	codice
1xG24-q3 26W	Bianco	G1806.16
1xG24-q3 26W	Grigio	G1806.18
1xG24-q3 26W	Foglia Oro	G1806.19
1xG24-q3 26W	F. Argento	G1806.20
LED SMD 7.7W 4500K	Bianco	G1806.36
LED SMD 7.7W 4500K	Grigio	G1806.38
LED SMD 7.7W 4500K	Foglia Oro	G1806.39
LED SMD 7.7W 4500K	F. Argento	G1806.40





IBISCUS

Design Ufficio Tecnico

LED
SMD



Serie di lampade a luce diffusa da parete, soffitto e sospensione. Struttura in metallo con finiture in nichel satinato. Diffusore in vetro extrachiaro serigrafato e satinato. Disponibile anche con illuminazione a LED SMD multi-chip a luce bianca naturale.

Range of wall, ceiling and pendant lamps giving diffused light. Metal frame available in a brushed nickel finish. Silk-screen printed and satin glass diffuser. Also available with multi-chip SMD LED natural white light.

Leuchten Serie mit Streulicht für Wand-, Decken und Hängeleuchte, Metallarmatur, Nickel satiniert. Diffusor aus extra-klarem und siebgedrucktem Glas. Die Leuchte ist auch mit LED SMD multi-chip erhältlich, weiß Tageslicht.

Collection d'appliques, lampes de table, lampadaires et suspensions à lumière diffuse. Structure en métal, finition nickel satiné. Diffuseur en verre extra-clair serigraphié satiné. Le produit est aussi disponible dans la version avec LED SMD multi-chip, lumière blanche naturelle.

Serie de lámparas de luz difusa para pared, techo y suspensión. Estructura de metal con acabado en níquel satinado. Difusor de cristal extra-claro, serigrafiado y satinado. Disponible también con LED SMD multi-chip a luz blanca natural.



Bianco



Arancio

Modelli depositati / Patent pending

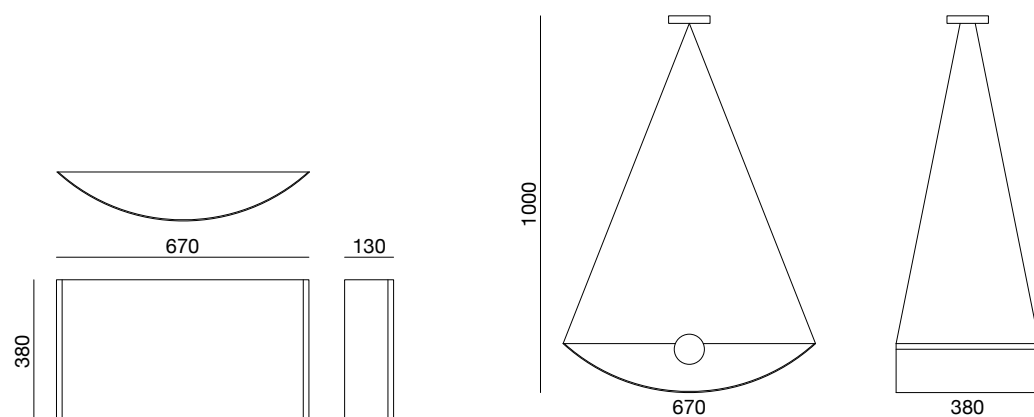

elettrificazione	colore	codice
1xR7s 160W 118mm	Bianco	G1805.15
2xG11 36W	Bianco	G1805.17
2xE27 42W	Bianco	G1805.19
1xLED SMD 19W 4500K	Bianco	G1805.45

IP 20

elettrificazione	colore	codice
1xR7s 230W 118mm	Bianco	G1805.21

IP 20

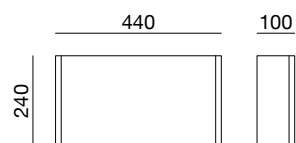

elettrificazione	colore	codice
1xR7s 160W 118mm	Bianco	G1805.09
1xR7s 160W 118mm	Arancio	G1805.10
2xE27 42W	Bianco	G1805.11
2xE27 42W	Arancio	G1805.12
2xG11 18W	Bianco	G1805.13
2xG11 18W	Arancio	G1805.14
LED SMD 15.4W 4500K	Bianco	G1805.39
LED SMD 15.4W 4500K	Arancio	G1805.40

IP 20

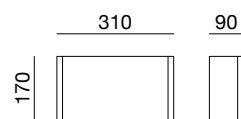

elettrificazione	colore	codice
1xR7s 120W 118mm	Bianco	G1805.03
1xR7s 120W 118mm	Arancio	G1805.04
2xE14 42W	Bianco	G1805.05
2xE14 42W	Arancio	G1805.06
2xG23 9W	Bianco	G1805.07
2xG23 9W	Arancio	G1805.08
LED SMD 6.6W 4500K	Bianco	G1805.33
LED SMD 6.6W 4500K	Arancio	G1805.34

IP 20

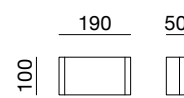

elettrificazione	colore	codice
1xG9 48W	Bianco	G1805.01
1xG9 48W	Arancio	G1805.02
LED SMD 2.2W 4500K	Bianco	G1805.31
LED SMD 2.2W 4500K	Arancio	G1805.32

IP 20





G1805.11



HEMMY

Design Christian Pavanello

Lampade a luce diffusa. Il diffusore è disponibile in ceramica o nella nuova versione in vetro soffiato, disponibile in bianco per la versione ceramica, mentre la versione vetro è disponibile rossa, bianca o nera. Struttura in metallo cromato.

Lamps giving diffused light. The diffuser is available in white ceramic and in blown glass as well (red, black or white). Frame made of chromium-plated metal.

Lampen aus diffusem Licht. Diffusor erhältlich in Keramik (lieferbar in weiß) oder mit geblasenem Glas (rot, schwarz oder weiß). Struktur aus verchromtem Metall.

Lampes à lumière diffuse. Diffuseur disponible soit en céramique en blanc, que en verre soufflé dans les couleurs rouge, noir et blanc. Structure en chromé brillant.

Luminaria de techo o de apoyo de luz difusa. Difusor de cerámica o en la nueva versión de cristal soplado; color blanco para la versión en cerámica, rojo, negro ó blanco para la versión en cristal. Estructura en acabado cromo brillante.

Modelli depositati / Patent pending



Vetro Bianco



Vetro Rosso



Ceramica Bianco



Ceramica Nero

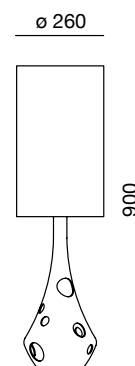
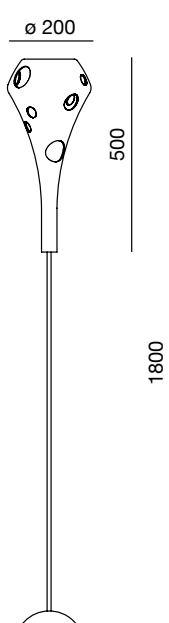
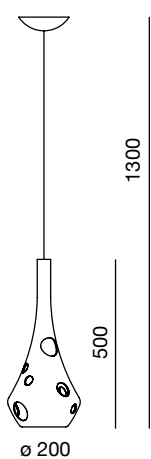

CERAMICA / CERAMIC

elettrificazione	colore	codice
1xE27 52W	Bianco	M136.1
1xE27 52W	Nero	M136.17

IP 20

VETRO / GLASS

elettrificazione	colore	codice
1xE27 70W	Bianco	M136.14
1xE27 70W	Rosso	M136.15

dimmer IP 20

CERAMICA / CERAMIC

elettrificazione	colore	codice
1xE27 52W	Bianco	M136.5
+ 1xE14 max 28W		

IP 20

VETRO / GLASS

elettrificazione	colore	codice
1xE27 52W	Nero	M136.6
1xE27 52W	Bianco	M136.7
1xE27 52W	Rosso	M136.8

IP 20





M136.8



M136.7

M136.5



ARTISTIC

Design Ufficio Tecnico

Serie di lampade a luce diffusa e diretta, struttura in metallo cromato. Il diffusore è in filo di vetro colato lavorato a mano, la particolare lavorazione crea giochi di luce che si diffondono nell'ambiente; disponibile in versione cristallo e metallizzato trasparente in argento. Disponibili nelle versioni a sospensione e parete.

Collection of lamps giving diffused light. Frame made of chromium-plated metal, hand made cast glass resulting in unique rays of light. Available as a pendant or as a wall luminaire, in a choice of clear glass or in a transparent metallized silver finish.

Kollektion von Hänge- und Wandleuchten mit diffusem Licht. Struktur aus verchromtem Metall; Diffusor aus handgemachtem Gußglas, welches sich jedem Einrichtungsstil, klassisch oder modern, anpasst. Erhältlich in den Ausführungen Kristall sowie in metallisiertem transparentem Silber.

Collection de lampes à lumière diffuse, disponibles en suspension et en applique. Structure en métal chromée, diffuseur en verre coulé fait à la main. Disponible dans les finitions cristal ou métallisé transparent silver.

Serie de luminarias de luz difusa, estructura de metal cromado. Difusor de cristal artistico colado a mano, disponible en versiones de suspensión y pared. Acabados cristal ó metallizado transparente silver.

Modelli depositati / Patent pending



Cromo



Cristallo



Nero

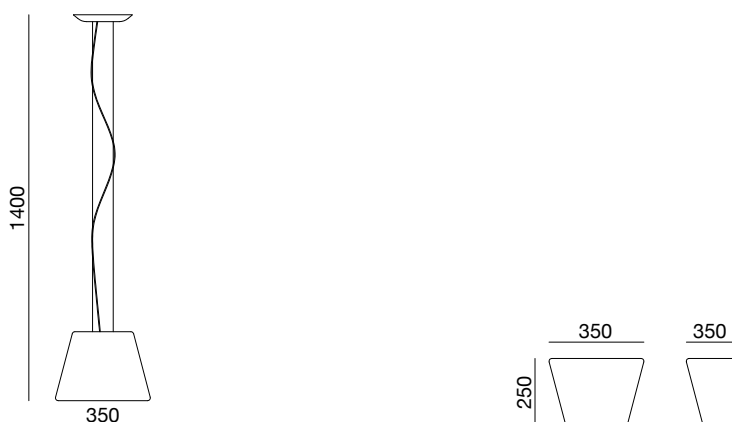

elettrificazione	colore	codice
1xE27 70W	Cromo	G0405.01
1xE27 70W	Cristallo	G0405.02
1xE27 70W	Nero	G0405.03



elettrificazione	colore	codice
1xE27 70W	Cromo	G0405.11
1xE27 70W	Cristallo	G0405.12
1xE27 70W	Nero	G0405.13







G0405.11

G0405.03



G0405.02

SCOTCH

Design Christian Pavanello

LED
SMD



Lampada a luce riflessa. Il diffusore è in vetro lavorato a mano, struttura in metallo, particolari in nichel spazzolato. Disponibile anche con illuminazione a LED SMD multi-chip a luce bianca naturale.

Wall luminaire giving reflecting light. Hand made glass diffuser, metal frame, brushed nickel parts. Also available with multi-chip SMD LED natural white light.

Wandleuchte mit reflektierendem Licht. Handgemachter Glas-Diffusor, Metallstruktur, Teile Nickel gebürstet. Die Leuchte ist auch mit LED SMD multi-chip erhältlich, weiß Tageslicht.

Applique en verre fait à la main à lumière réfléchant, structure en métal, détails en nickel brossé. Le produit est aussi disponible dans la version avec LED SMD multi-chip, lumière blanche naturelle.

Luminaria con luz refleja. El difusor de cristal trabajado a mano, estructura de metal, complementos en níquel bruñido. Disponible también con LED SMD multi-chip a luz blanca natural.

Modelli depositati / Patent pending





Nero

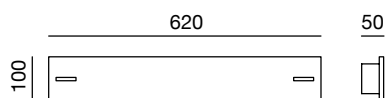

Bianco



elettrificazione		colore	codice
2xG5 24W		Nero	M139.1
2xG5 24W		Bianco	M139.2
LED SMD 15.4W 4500K		Nero	M139.3
LED SMD 15.4W 4500K		Bianco	M139.4









SIXTY

Design Roberto Favaretto

Serie di lampade a luce diffusa da parete, tavolo, terra e sospensione. Struttura in metallo cromato, base in metallo verniciata nei colori bianco o nero. Diffusore in vetro extrachiaro serigrafato bianco o serigrafato nero e satinato o foglia oro 24k. Il decoro riprende motivi tipici degli anni sessanta rivisitandoli in un contesto attuale, creando interessanti effetti di trasparenze e bagliori diffusi.

Range of wall, table, floor and pendant lamps giving diffused light. Metal frame in chrome finish, painted base. Glass diffuser white silk-screen printed or satin black silk-screen printed or with gold foil. The collection is inspired by the 60s, yet still having a contemporary style; the elegant effects of transparencies and flashes make it unique for domestic and contract applications.

Leuchten Serie mit Streulicht für Wand-, Tisch-, Steh- und Hängeleuchte, Metallarmatur chrom, Basis lackiert. Diffusor aus extra-klarem und siebgedrucktem Glas weiß oder siebgedrucktem schwarz satiniert oder mit Gold-Folie. Die Kollektion inspiriert sich zu den 60er-Jahren, jedoch mit einer Touch cooler Technik. Das Dekor des Glases bietet interessante Spiele von Transparenzen und diffusen Schimmern an. Geeignet für den Wohnbereich sowie auch für die Hotellerie.

Collection d'appliques, lampes de table, lampadaires et suspensions à lumière diffuse. Structure en métal, finition chromé, base vernisé. Diffuseur en verre extra-clair serigraphié blanc ou serigraphié noir et satiné ou avec détails en feuille or. Le décor reprend le style des années 60, toutefois lui donnant une touche absolument unique de fraîcheur et originalité dans le design. À noter les effets de transparence et de lueurs du verre serigraphié.

Serie de lámpara de luz difusa de pared, mesa, de pie y suspensión. Estructura de metal cromado, base pintada. Difusor de cristal extra-claro serigrafado blanco ó serigrafado negro y satinado ó con lámina de oro. La decoración toma motivos típicos de los años sesenta adecuándolos a un contexto actual, creando interesantes efectos de transparencia y difusos.



Bianco



Nero



Oro

Modelli depositati / Patent pending

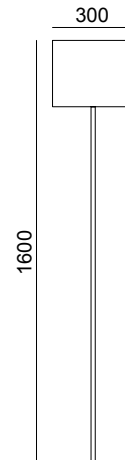
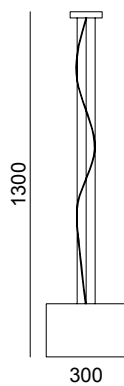
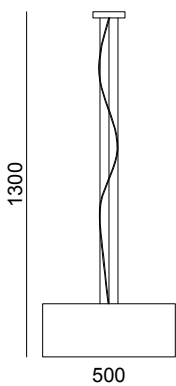

elettrificazione	colore	codice
3xE27 52W	Bianco	G1807.01
3xE27 52W	Nero	G1807.02
3xE27 52W	Oro	G1807.21

IP 20

elettrificazione	colore	codice
1xE27 70W	Bianco	G1807.03
1xE27 70W	Nero	G1807.04
1xE27 70W	Oro	G1807.23

IP 20

elettrificazione	colore	codice
1xE27 105W	Bianco	G1807.09
1xE27 105W	Nero	G1807.10
1xE27 105W	Oro	G1807.29

dimmer IP 20

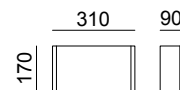
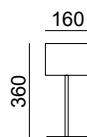
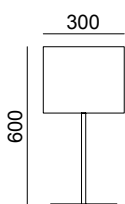

elettrificazione	colore	codice
1xE27 70W	Bianco	G1807.05
1xE27 70W	Nero	G1807.06
1xE27 70W	Oro	G1807.25

IP 20

elettrificazione	colore	codice
1xG9 48W	Bianco	G1807.07
1xG9 48W	Nero	G1807.08
1xG9 48W	Oro	G1807.27

IP 20

elettrificazione	colore	codice
1xR7s 120W 118mm	Bianco	G1807.11
1xR7s 120W 118mm	Nero	G1807.12
1xR7s 120W 118mm	Oro	G1807.31
2xE14 42W	Bianco	G1807.13
2xE14 42W	Nero	G1807.14
2xE14 42W	Oro	G1807.33
2xG23 9W	Bianco	G1807.15
2xG23 9W	Nero	G1807.16
2xG23 9W	Oro	G1807.35

IP 20











G1807.21





G1807.05

JAZZ

Design Fly Design

LED
SMD



Lampade a luce diretta e diffusa. La struttura è in metallo bianco verniciato, cromo lucido o nichel spazzolato e diffusore in vetro satinato. Disponibile anche con illuminazione a LED SMD multi-chip a luce bianca naturale.

Lamps giving direct and diffused light. Frame available in white painted, polished chrome or brushed nickel with satin glass diffuser. Also available with multi-chip SMD LED natural white light.

Lampen mit direktem und diffusem Licht. Struktur aus Metall, Ausführung weiß lackiert, chrom glänzend oder nickel gebürstet. Diffusor aus satiniertem Glas. Die Leuchte ist auch mit LED SMD multi-chip erhältlich, weiß Tageslicht.

Collections de lampes à lumière directe et diffuse. Structure en métal disponible en blanc, chromé brillant ou nickel brossé. Diffuseur en verre satiné. Le produit est aussi disponible dans la version avec LED SMD multi-chip, lumière blanche naturelle.

Luminaria de luz directa y difusa. La estructura es de metal disponible en acabado pintado blanco, cromo ó níquel bruñido. Difusor de cristal satinado. Disponible tambien con LED SMD multi-chip a luz blanca natural.

Modelli depositati / Patent pending



Nichel spazzolato



Cromo



Bianco

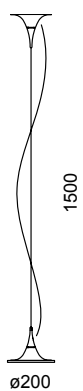

elettrificazione		finitura	codice
1xG9 33W		Nichel Spazzolato	M140.1
1xG9 33W		Cromo	M140.2
1xG9 33W		Bianco	M140.4
1xLED SMD 2.9W 4500K		Nichel Spazzolato	M140.21
1xLED SMD 2.9W 4500K		Cromo	M140.22
1xLED SMD 2.9W 4500K		Bianco	M140.24

IP 20



M140.4





SLIM

Design Ufficio Tecnico

LED
SMD



Serie di lampade da parete a luce indiretta o diffusa. Struttura in metallo verniciato. I riflettori possono essere in metallo con finitura nichel spazzolato, bianco o foglia oro; oppure in vetro con le seguenti finiture: vetro verniciato bianco o specchio. Le elettrificazioni possono essere a scelta fra fluorescenza, incandescenza, alogena e LED SMD multichip.

Wall mounted luminaire for down/upwards or diffuse light emission with a simple and essential design. For use with compact fluorescent, incandescence, halogen or Multichip LEDs. Body in painted metal, front cover in a choice of brushed nickel or painted metal (white or gold foil), white painted glass or mirror. Satin pyrex glass on top and bottom.

Moderne Wandleuchte mit einfachen und Minimalinien mit indirekter oder diffuser Lichtverteilung. Für Energiesparlampen, Glühlampen, Halogenlicht sowie auch mit Multichip LED. Struktur aus Metall lackiert, Frontabdeckung erhältlich in verschiedenen Oberflächen: Nickel gebürstet, Metall weiß lackiert oder blattvergoldet, Glas weiß satiniert mit transparentem Rand oder Spiegelglas. Top- und Unterteil aus satiniertem Pyrexglas.

Moderne série d'appliques pour utilisation en intérieur au design simple et minimaliste, donnant éclairage indirecte ou diffuse. Pour utilisation avec des lampes fluocompactes, à incandescence, halogènes ou LED Multichip. Structure en métal vernisé, diffuseur frontal disponible en métal vernisé blanc, décoré à la feuille d'or ou en nickel brossé; disponible aussi en verre vernisé blanc ou en verre glace.

Aparato de iluminación de pared, fijo, para utilizar en ambiente interno, para iluminación indirecta y difusa. La iluminación la facilita una lámpara a incandescencia, fluorescencia, halógena ó LED Multichip. El cuerpo de la lámpara esta construido en metal pintado blanco, la parte frontal es disponible en acero ligeramente bruñido, metal pintado blanco, vidrio pintado blanco o vidrio espejo.



bianco



nichel spazzolato



vetro specchio



vetro bianco



foglia oro

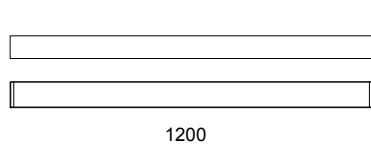

SLIM 120

elettrificazione	colore	codice
2xG5 54W	Bianco	M206.15
LED SMD 46.2W	Bianco	M206.115
2xG5 54W	Nichel Spazzolato	M206.05
LED SMD 46.2W	Nichel Spazzolato	M206.105
2xG5 54W	Vetro Specchio	M206.65
LED SMD 46.2W	Vetro Specchio	M206.165
2xG5 54W	Vetro Bianco	M206.75
LED SMD 46.2W	Vetro Bianco	M206.175
2xG5 54W	Foglia Oro	M206.215
LED SMD 46.2W	Foglia Oro	M206.315

IP 20 V E CE

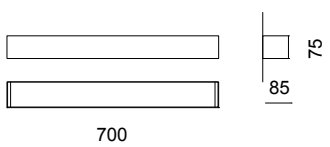

SLIM 70

elettrificazione	colore	codice
2x2G11 24W	Bianco	M206.16
LED SMD 30.8W	Bianco	M206.116
2x2G11 24W	Nichel Spazzolato	M206.06
LED SMD 30.8W	Nichel Spazzolato	M206.106
2x2G11 24W	Vetro Specchio	M206.66
LED SMD 30.8W	Vetro Specchio	M206.166
2x2G11 24W	Vetro Bianco	M206.76
LED SMD 30.8W	Vetro Bianco	M206.176
2x2G11 24W	Foglia Oro	M206.216
LED SMD 30.8W	Foglia Oro	M206.316

IP 20 V E CE

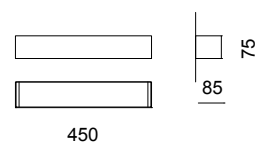

SLIM 45

elettrificazione	colore	codice
1x2G11 36W	Bianco	M206.19
LED SMD 15.4W	Bianco	M206.119
1x2G11 36W	Nichel Spazzolato	M206.09
LED SMD 15.4W	Nichel Spazzolato	M206.109
1x2G11 36W	Vetro Specchio	M206.69
LED SMD 15.4W	Vetro Specchio	M206.169
1x2G11 36W	Vetro Bianco	M206.79
LED SMD 15.4W	Vetro Bianco	M206.179
1x2G11 36W	Foglia Oro	M206.219
LED SMD 15.4W	Foglia Oro	M206.319

IP 20 V E CE



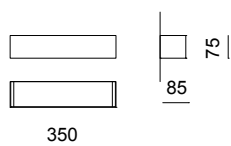

SLIM 35

elettrificazione	colore	codice
1xR7s 120W 118mm	Bianco	M206.17
1x2G11 24W elettro-	Bianco	M206.14
2xG24-d2 18W indut-	Bianco	M206.18
LED SMD 11W 4500K	Bianco	M206.114
1xR7s 120W 118mm	Nichel Spazzo-	M206.07
1x2G11 24W elettro-	Nichel Spazzo-	M206.04
2xG24-d2 18W indut-	Nichel Spazzo-	M206.08
LED SMD 11W 4500K	Nichel Spazzo-	M206.104
1xR7s 120W 118mm	Vetro Specchio	M206.67
1x2G11 24W elettro-	Vetro Specchio	M206.64
2xG24-d2 18W indut-	Vetro Specchio	M206.68
LED SMD 11W 4500K	Vetro Specchio	M206.164
1xR7s 120W 118mm	Vetro Bianco	M206.77
1x2G11 24W elettro-	Vetro Bianco	M206.74
2xG24-d2 18W indut-	Vetro Bianco	M206.78
LED SMD 11W 4500K	Vetro Bianco	M206.174
1xR7s 120W 118mm	Foglia Oro	M206.217
1x2G11 24W elettro-	Foglia Oro	M206.214
2xG24-d2 18W indut-	Foglia Oro	M206.218
LED SMD 11W 4500K	Foglia Oro	M206.314

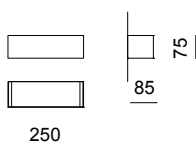

SLIM 25

elettrificazione	colore	codice
1xR7s 80W 78mm	Bianco	M206.12
1x2G11 18W elettro-	Bianco	M206.13
1xG24-d3 26W	Bianco	M206.20
LED SMD 6.6W	Bianco	M206.112
1xR7s 80W 78mm	Nichel Spazzolato	M206.02
1x2G11 18W elettro-	Nichel Spazzolato	M206.03
1xG24-d3 26W	Nichel Spazzolato	M206.10
LED SMD 6.6W	Nichel Spazzolato	M206.102
1xR7s 80W 78mm	Vetro Specchio	M206.62
1x2G11 18W elettro-	Vetro Specchio	M206.63
1xG24-d3 26W	Vetro Specchio	M206.60
LED SMD 6.6W	Vetro Specchio	M206.162
1xR7s 80W 78mm	Vetro Bianco	M206.72
1x2G11 18W elettro-	Vetro Bianco	M206.73
1xG24-d3 26W	Vetro Bianco	M206.70
LED SMD 6.6W	Vetro Bianco	M206.172
1xR7s 80W 78mm	Foglia Oro	M206.212
1x2G11 18W elettro-	Foglia Oro	M206.213
1xG24-d3 26W	Foglia Oro	M206.220
LED SMD 6.6W	Foglia Oro	M206.312

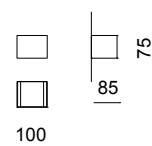

SLIM 10

elettrificazione	colore	codice
1xG9 33W	Bianco	M206.11
LED SMD 2.2W	Bianco	M206.111
1xG9 33W	Nichel Spazzolato	M206.01
LED SMD 2.2W	Nichel Spazzolato	M206.101
1xG9 33W	Vetro Specchio	M206.61
LED SMD 2.2W	Vetro Specchio	M206.161
1xG9 33W	Vetro Bianco	M206.71
LED SMD 2.2W	Vetro Bianco	M206.171
1xG9 33W	Foglia Oro	M206.211
LED SMD 2.2W	Foglia Oro	M206.311





M206.01





HOLE

Design Christian Pavanello

Lampada a luce diffusa. Diffusore in policarbonato. L'elemento decorativo è un pannello in legno finitura tipo wengé o palissandro con anello in cromo, struttura in metallo verniciato.

Wall/ceiling lamps giving diffused light. Wood square frame - wengé or palysander like -. Painted metal backplate with polycarbonate ring.

Wand- und Deckenleuchten aus diffusem Licht. Holzdifusor lieferbar in Typ Wengé oder Palyssander, Struktur aus lackiertem Metall mit Ring aus Polykarbonat.

Lampes à lumière diffuse. Diffuseur carré en bois, disponible en type wengé ou palyssandre. Structure en métal vernisé avec anneau en Polycarbonate.

Luminaria cuadra de techo o de pared de luz difusa. Difusor de madera tipo wengé o palyssandro, estructura de metal pintado y anillo en polycarbonado.

Modelli depositati / Patent pending



Wengé



Palissandro

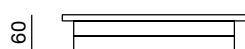
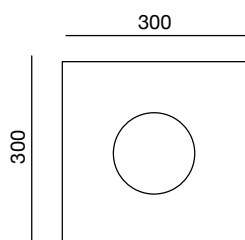

elettrificazione	colore	codice
1x2GX13 22W	○ Wengé	M142.1
1x2GX13 22W	○ Palissandro	M142.2



M142.1



M142.2

FRESH

Design Ufficio Tecnico

Serie di lampade a luce diffusa da parete, da soffitto o da tavolo. Diffusore in vetro opale satinato. Struttura in metallo verniciato bianco o cromato.

Range of wall, ceiling, pendant and table luminaires with diffuse light. Opal satin glass diffuser. Metal white painted or chromed frame.

Kollektion von Wand-, Decken-, Pendel- und Tischleuchten mit diffusem Licht. Diffusor aus Opalsatiniertem Glas. Struktur Struktur aus lieferbar in weiß oder verchromtem Metall.

Collection d'appliques, plafonniers, suspensions et lampes à poser. Diffuseur en verre opale satiné. Structure en métal vernissé blanc ou chromé.

Serie de luminarias de luz difusa de pared, de techo o de mesa. Difusor de cristal opal satinado. La estructura metálica es pintada blanco o cromada.



Bianco



Cromo

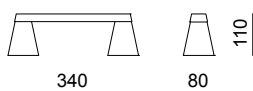
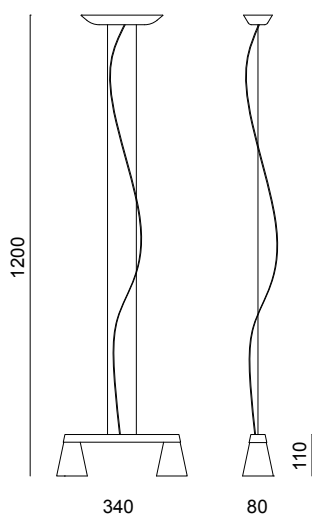

elettrificazione	finitura	codice
2xG9 48W	Bianco	G1815.01
2xG9 48W	Cromo	G1815.02

IP 20

elettrificazione	finitura	codice
2xG9 48W	Bianco	G1815.03
2xG9 48W	Cromo	G1815.04

IP 20

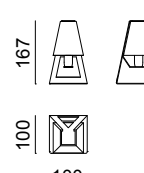
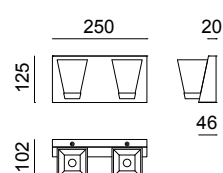
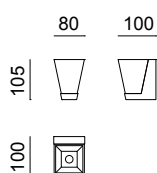

elettrificazione	finitura	codice
1xG9 48W	Bianco	G1815.05
1xG9 48W	Cromo	G1815.06

IP 20

elettrificazione	finitura	codice
2xG9 48W	Bianco	G1815.07
2xG9 48W	Cromo	G1815.08

IP 20

elettrificazione	finitura	codice
1xG9 48W	Bianco	G1815.09
1xG9 48W	Cromo	G1815.10

IP 20







G1815.01



G1815.06



TOAST

Design Ufficio Tecnico

LED
SMD



Lampade a luce diffusa. Struttura in metallo nichelato. Diffusore in vetro extrachiaro serigrafato. Disponibile anche con illuminazione a LED SMD multi-chip a luce bianca naturale.

Lamps giving diffused light. Metal nickered frame. Extralight silk-screen glass diffuser. Also available with multi-chip SMD LED natural white light.

Lampen mit diffusem Licht. Struktur aus vernickeltem Metall. Extraheller siebgedruckter Glasdiffusor. Die Leuchte ist auch mit LED SMD multi-chip erhältlich, weiß Tageslicht.

Collection de lampes à lumière diffuse. Structure en métal nickelé. Diffuseur en verre extra-clair sérigraphié. Le produit est aussi disponible dans la version avec LED SMD multi-chip, lumière blanche naturelle.

Luminaria de luz difusa. Estructura en metal niquelado. Difusor de cristal extraclaro serografiado. Disponible tambien con LED SMD multi-chip a luz blanca natural.

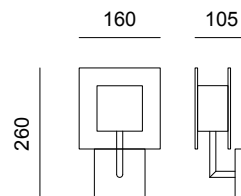
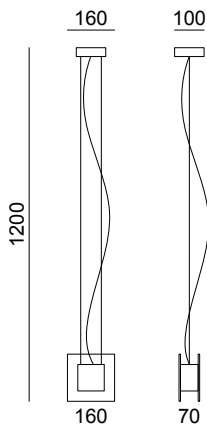
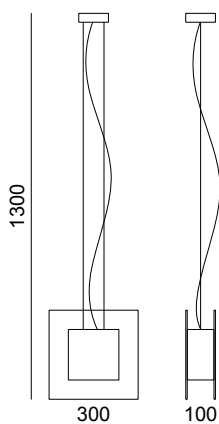

elettrificazione	finitura	codice
1xE27 70W	Trasp.+Bianco	G1804.01
LED SMD 6.6W 4500K	Trasp.+Bianco	G1804.11



elettrificazione	finitura	codice
1xG9 48W	Trasp.+Bianco	G1804.02
1x LED SMD 2.9W 4500K	Trasp.+Bianco	G1804.12



elettrificazione	finitura	codice
1xG9 33W	Trasp.+Bianco	G1804.06
1x LED SMD 2.9W 4500K	Trasp.+Bianco	G1804.16

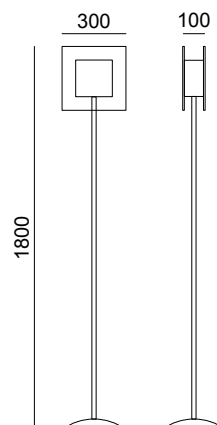
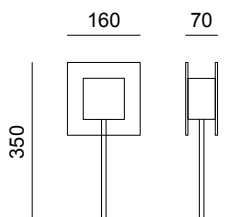
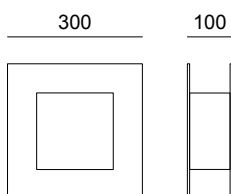

elettrificazione	finitura	codice
1xE27 42W	Trasp.+Bianco	G1804.03



elettrificazione	finitura	codice
1xG9 33W	Trasp.+Bianco	G1804.04



elettrificazione	finitura	codice
1xE27 70W	Trasp.+Bianco	G1804.05







G1804.06

G1804.01



G1804.03

G1804.04

FLUTE 1

Design Ufficio Tecnico

Serie di lampade a luce diffusa. Struttura in metallo cromato, vetro soffiato satinato o foglia oro 24k.

Lamps giving diffused light. Metal chromed frame, satin blown glass diffuser or with gold foil.

Lampen mit diffusem Licht. Struktur aus verchromtem Metall, geblasenes satiniertes Glas oder mit Gold-Folie.

Collection de lampes à lumière diffuse. Structure en métal chromé, verre soufflé satiné ou avec détails en feuille or.

Serie de aparatos de luz difusa. Estructura en metal cromado, cristal soplado satinado ó con lámina de oro.

Modelli depositati / Patent pending



Satinato



Foglia Oro

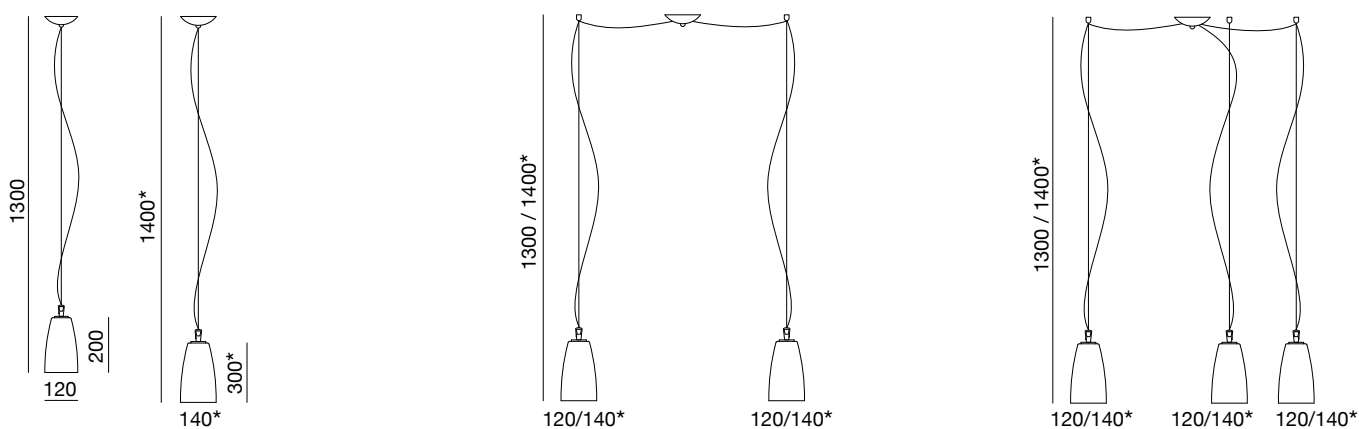

elettrificazione	colore	codice
1xE27 52W	Trasp. + Satinato	G1095.03
1xE27 52W	Trasp. + Satinato	G1095.04*
1xE27 52W	Foglia Oro	G1095.13
1xE27 52W	Foglia Oro	G1095.14*



elettrificazione	colore	codice
2xE27 42W	Trasp. + Satinato	G1095.05
2xE27 42W	Trasp. + Satinato	G1095.06*
2xE27 42W	Foglia Oro	G1095.15
2xE27 42W	Foglia Oro	G1095.16*



elettrificazione	colore	codice
3xE27 42W	Trasp. + Satinato	G1095.07
3xE27 42W	Trasp. + Satinato	G1095.08*
3xE27 42W	Foglia Oro	G1095.17
3xE27 42W	Foglia Oro	G1095.18*

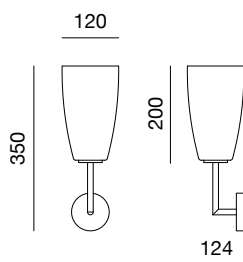
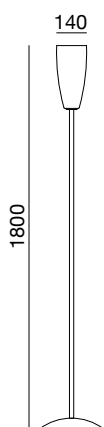

elettrificazione	colore	codice
1xE27 250W	Trasp. + Satinato	G1095.02
1xE27 250W	Foglia Oro	G1095.12

dimmer



Trasp. + Satinato
Foglia Oro





G1095.11



G1095.14



G1095.01



G1095.05



CANNE

Design Christian Pavanello

Serie di lampade a luce diffusa da parete, da soffitto o da terra. Il diffusore si caratterizza da una sequenza alternata di canne in vetro di Murano, colore Blu o Ambra e bianche. Unico è il risultato che ne consegue, dagli esclusivi riflessi di luce. Struttura in metallo nickel spazzolato.

Range of wall, ceiling, pendant and floor luminaires with diffuse light. Diffuser characterised by an alternate sequence of Murano glass tubes in blue and white or amber and white. The play of light rays makes this collection unique in its kind. Frame in nickel brushed.

Kollektion von Wand-, Decken-, Pendel- und Stehleuchten mit diffusem Licht. Diffusor aus Murano Glasröhre lieferbar in Wechselfarben, hellblau und weiß oder amber und weiß. Die Lichteffekte machen diese Kollektion einzig in seiner Art. Struktur Nickel gebürstet.

Collection d'appliques, plafonniers, suspensions et lampadaires. Diffuseur caractérisé par une suite alternée de cannes en verre de Murano disponibles en bleu et blanc ou ambre et blanc. Les exclusifs reflets de la lumière font de cette collection une gamme unique. Structure en nickel brossé.

Serie de luminarias de luz difusa de pared, de techo o de pié. El difusor se caracteriza por una secuencia alterna de tubo de cristal de Murano, color Azul o Ambar y Blanco. El resultado que se consigue es único, con los exclusivos reflejos de la luz. La estructura metálica es en niquel bruñido.



Blu



Ambra



Cristallo

Modelli depositati / Patent pending

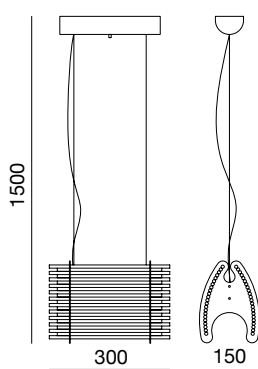

elettrificazione	colore	codice
1xR7s 120W 118mm	Blu	M107.5
1xR7s 120W 118mm	Ambra	M107.6
1xR7s 120W 118mm	Cristallo	M107.13

IP 20 V E CE

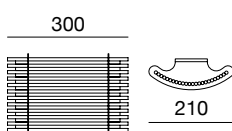

elettrificazione	colore	codice
2xG9 48W	Blu	M107.3
2xG9 48W	Ambra	M107.4
2xG9 48W	Cristallo	M107.12

IP 20 V E CE

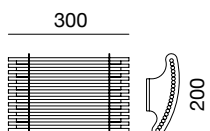

elettrificazione	colore	codice
1xR7s 120W 118mm	Blu	M107.1
1xR7s 120W 118mm	Ambra	M107.2
1xR7s 120W 118mm	Cristallo	M107.11

IP 20 V E CE

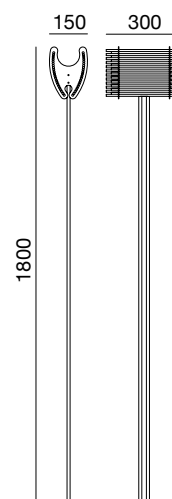

elettrificazione	colore	codice
1xR7s 230W 118mm	Blu	M107.7
1xR7s 230W 118mm	Ambra	M107.8
1xR7s 230W 118mm	Cristallo	M107.14

dimmer IP 20 V E CE

M107.2



M107.7

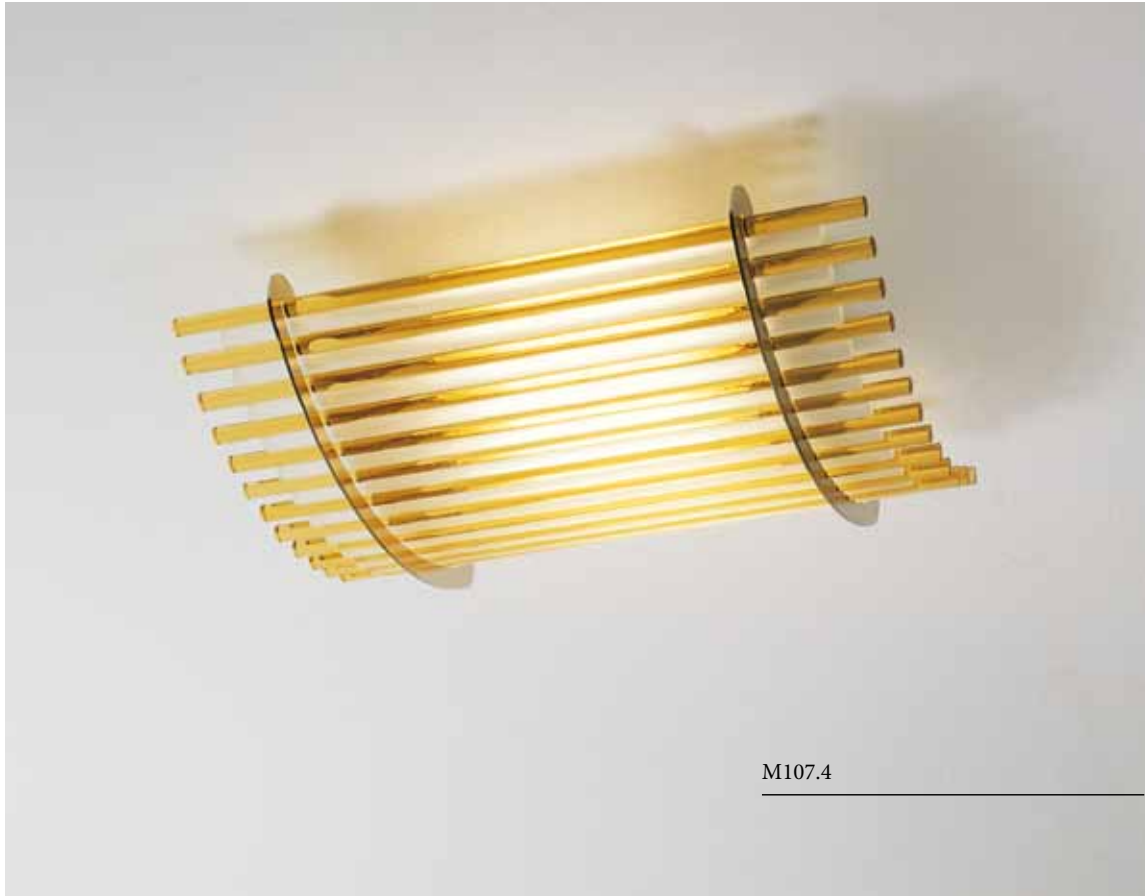

M107.4

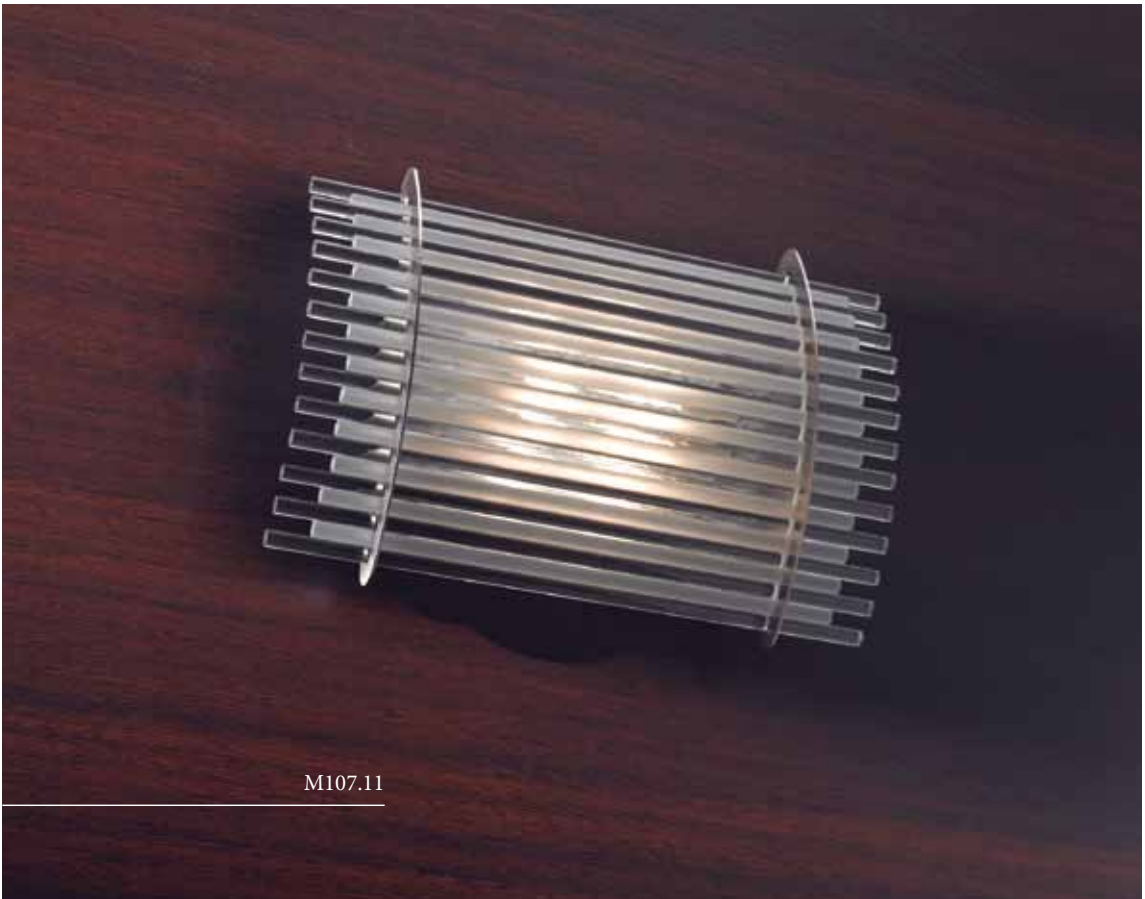

M107.11



OCHEI

Design Ufficio Tecnico

LED
SMD



Lampada a luce diffusa, diretta. Diffusore in vetro trasparente, struttura in metallo con finiture nichel spazzolato. Disponibile anche con illuminazione a LED SMD multi-chip a luce bianca naturale.

Lamp giving diffused direct light. Transparent glass diffuser, metal frame with nickel brushed parts. Also available with multi-chip SMD LED natural white light.

Lampen mit direktem diffusem Licht. Transparenter Glas-Diffusor, Struktur aus Metall mit nickel gebürsteten Teilen. Die Leuchte ist auch mit LED SMD multi-chip erhältlich, weiß Tageslicht.

Collection de lampes à lumière diffuse. Diffuseur en verre transparent, structure en métal avec parts en nickel brossé. Le produit est aussi disponible dans la version avec LED SMD multi-chip, lumière blanche naturelle.

Luminaria de luz difusa directa. Difusor de cristal transparente, estructura de metal y acabado en níquel bruñido. Disponible también con LED SMD multi-chip a luz blanca natural.

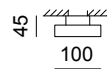
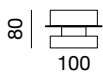
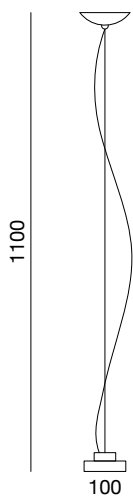

elettrificazione	finitura	codice
1xG9 33W 	Nichel Spazzo-	G2047.02
1xLED SMD 2.9W	Nichel Spazzo-	G2047.12

IP 20    CE

elettrificazione	finitura	codice
1xG9 33W 	Nichel Spazzo-	G2047.01
1xLED SMD 2.9W	Nichel Spazzo-	G2047.11

IP 20    CE

elettrificazione	finitura	codice
1xG9 33W 	Nichel Spazzo-	G2047.04
1xLED SMD 2.9W	Nichel Spazzo-	G2047.14

IP 20    CE





G2047.04



G2047.01

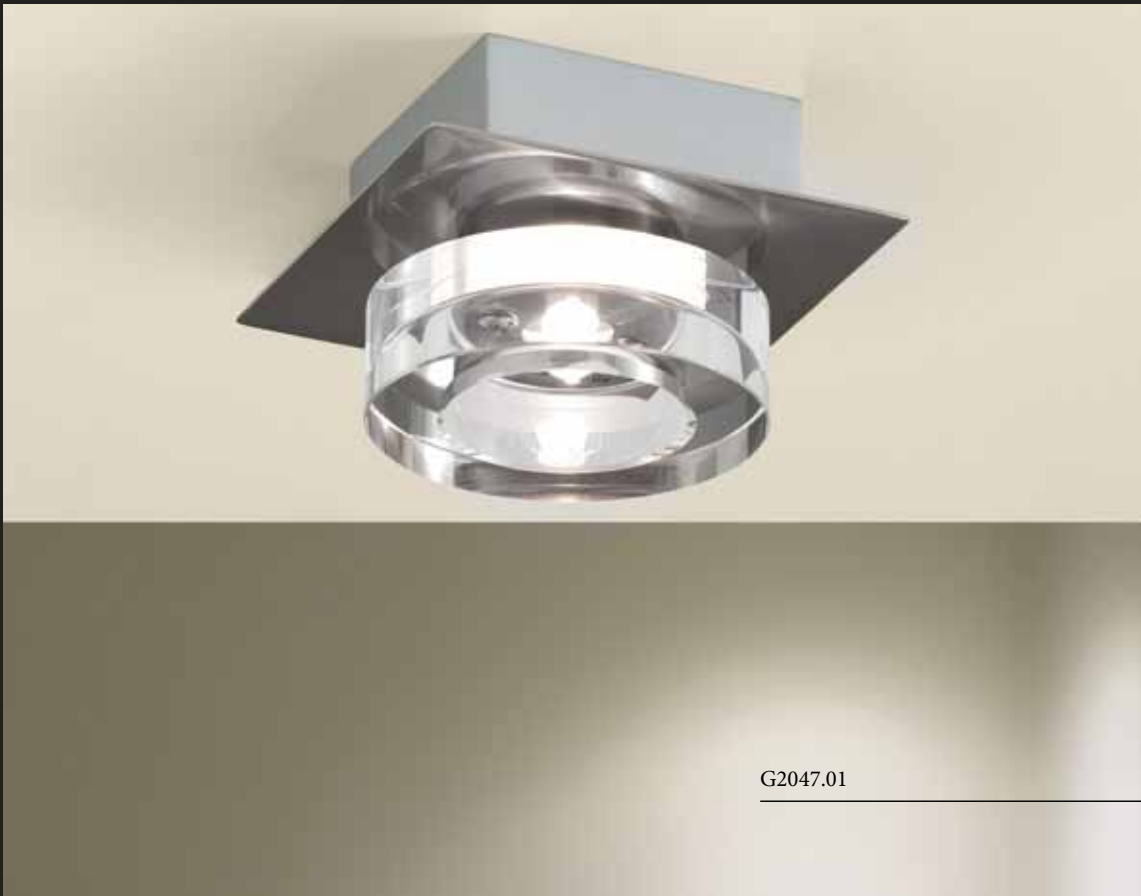

SLIDE

Design Ufficio Tecnico

LED
SMD



Serie di lampade a luce diffusa da parete, soffitto e sospensione. Struttura in metallo con finiture in nichel satinato. Diffusore in vetro extrachiaro serigrafato e satinato. Disponibile anche con illuminazione a LED SMD multi-chip a luce bianca naturale.

Wall-, ceiling- and Suspension lamps giving diffused light. Metal frame with nickel brushed parts. Extralight silk-screen and satin glass diffuser. Also available with multi-chip SMD LED natural white light.

Wand- Decken- und Hängeleuchten mit diffusem Licht. Metallstruktur mit nickel gebürsteten Teilen. Extra-heller siebgedruckter satiniertes Glasdiffusor. Die Leuchte ist auch mit LED SMD multi-chip erhältlich, weiß Tageslicht.

Collection d'appliques, plafonniers et suspensions avec lumière diffuse. Structure en métal avec détails en nickel brossé.

Diffuseur en verre extra-clair sérigraphié satiné. Le produit est aussi disponible dans la version avec LED SMD multi-chip, lumière blanche naturelle.

Serie de luminarias de luz difusa de pared, techo y suspensión. Estructura de metal con acabado en níquel satinado. Difusor de cristal extra-claro serigrafiado y satinado. Disponible también con LED SMD multi-chip a luz blanca natural.

Modelli depositati / Patent pending

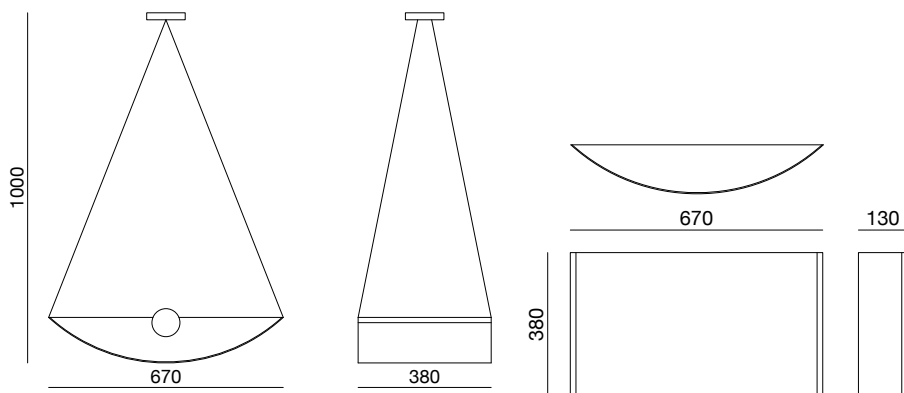

elettrificazione	finitura	codice
1xR7s 230W 118mm	Nichel sp.	G3110.08



elettrificazione	finitura	codice
1xR7s 160W 118mm	Nichel sp.	G3110.04
2xG11 36W	Nichel sp.	G3110.05
2xE27 42W	Nichel sp.	G3110.06
1xLED SMD 19W 4500K	Nichel sp.	G3110.18
2xG11 24W	Nichel sp.	G3110.07



Emergenza / Emergency

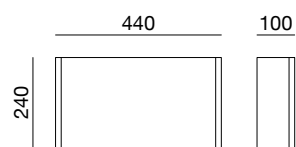

elettrificazione	finitura	codice
1xR7s 160W 118mm	Nichel sp.	G3110.10
2xE27 42W	Nichel sp.	G3110.11
2xG11 18W	Nichel sp.	G3110.12
LED SMD 15.4W 4500K	Nichel sp.	G3110.17

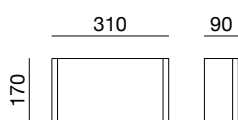

elettrificazione	finitura	codice
1xR7s 120W 118mm	Nichel sp.	G3110.01
2xG23 9W	Nichel sp.	G3110.02
2xE14 42W	Nichel sp.	G3110.03
LED SMD 6.6W 4500K	Nichel sp.	G3110.16

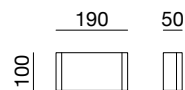

elettrificazione	finitura	codice
1xG9 48W	Nichel sp.	G3110.09
LED SMD 2.2W 4500K	Nichel sp.	G3110.15







Apertura del vetro diffusore a scorrimento / Sliding glass



FLUTE 2

Design Ufficio Tecnico

Serie di lampade a luce diffusa. Struttura in metallo nickel spazzolato, vetro soffiato satinato.

Lamps giving diffused light. Metal nickel brushed frame, satin blown glass diffuser.





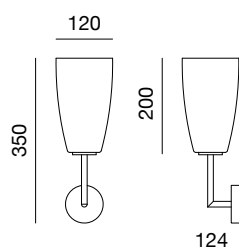

Lampen mit diffusem Licht. Struktur Nickel gebürstet Metall, geblasenes satiniertes Glas.

Collection de lampes à lumière diffuse. Structure en métal nickel brossé, verre soufflé satiné.







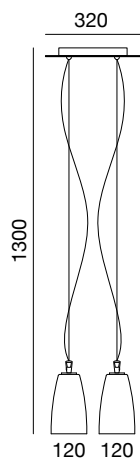

Serie de luminarias de luz difusa. Estructura de metal niquelado bruñido, cristal soplado satinado.

Modelli depositati / Patent pending







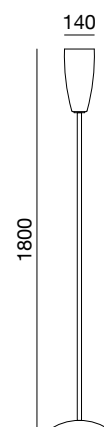

elettrificazione	colore	codice
1xE27 42W  	Satinato	G1096.01
   		









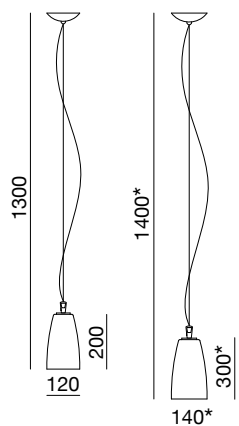

elettrificazione	colore	codice
4xE27 42W    	Satinato	G1096.08
   		









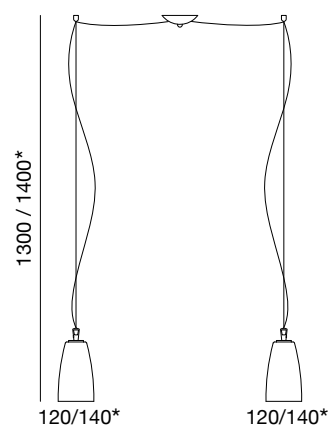

elettrificazione	colore	codice
1xE27 250W  	Satinato	G1096.09
    		









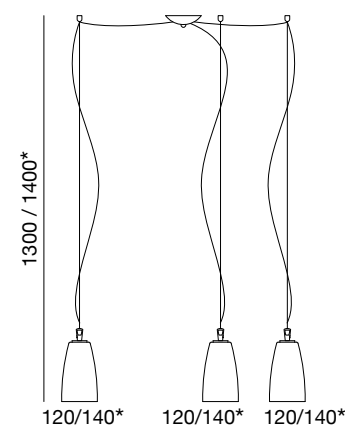



elettrificazione	colore	codice
1xE27 52W  	Satinato	G1096.02
1xE27 52W  	Satinato	G1096.03*
   		



elettrificazione	colore	codice
2xE27 42W  	Satinato	G1096.04
2xE27 42W  	Satinato	G1096.05*
   		



elettrificazione	colore	codice
3xE27 42W   	Satinato	G1096.06
3xE27 42W   	Satinato	G1096.07*
   		

G1096.01



G1096.03







G1096.09

G1096.04

BOCOLO

Design Ufficio Tecnico

Serie di lampade a luce diffusa da parete, da soffitto o da tavolo. Diffusore in vetro cristallo al piombo 18%: la particolare conformazione "ottica" della superficie permette esclusivi riflessi di luce. Struttura in metallo nickel spazzolato.

Range of wall, ceiling, pendant and table luminaires with diffuse light. Diffuser in 18% lead crystal glass and frame in nickel brushed. Characterised by unique reflections of light when switched on.





Kollektion von Wand-, Decken-, Pendel- und Tischleuchten mit diffusen Licht. Diffusor aus Bleikristall 18%: die Lichteffekte machen diese Kollektion einzig in seiner Art. Struktur Nickel gebürstet.

Collection d'appliques, plafonniers, suspensions et lampes à poser. Diffuseur en verre cristal au plomb 18% et structure en nickel brossé. Les exclusifs reflets de la lumière font de cette collection une gamme unique.

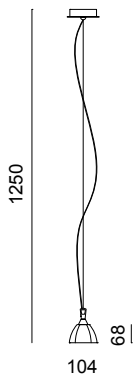



Serie de luminarias de luz difusa de pared, de techo o de pié. El difusor es en Cristal 18%. El resultado que se consigue es único, con los exclusivos reflejos de la luz. La estructura metálica es en níquel bruñido.

Modelli depositati / Patent pending

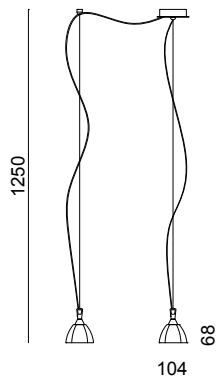





elettrificazione colore codice
1xG9 48W  Cristallo M152.03
   

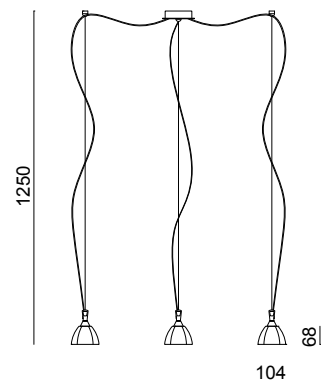





elettrificazione colore codice
2xG9 48W  Cristallo M152.04
   







elettrificazione colore codice
3xG9 48W  Cristallo M152.05
   







elettrificazione colore codice
1xG9 48W  Cristallo M152.01
   

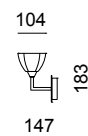

elettrificazione colore codice
1xG9 48W  Cristallo M152.06
   



elettrificazione colore codice
1xG9 48W  Cristallo M152.08
   



M152.03



M152.06



M152.01

FIACOLA

Design Ufficio Tecnico

LED
SMD



Lampade con diffusore in vetro soffiato opalino satinato. Struttura e particolari in metallo cromato satinato. Disponibile anche con illuminazione a LED SMD multi-chip a luce bianca naturale.

Lamps with etched opal blown glass diffuser. Metal frame and parts in satin chrome. Also available with multi-chip SMD LED natural white light.

Lampen mit geblasenem Opaldiffusor opal satiniert. Struktur und Teile aus Metall verchromt satiniert. Die Leuchte ist auch mit LED SMD multi-chip erhältlich, weiß Tageslicht.

Lampe avec diffuseur soufflé opale satiné. Structure et détails en métal chromé satiné. Le produit est aussi disponible dans la version avec LED SMD multi-chip, lumière blanche naturelle.

Luminaria con difusor de cristal soplado opal satinado ó bien ámbar. Estructura y complementos de metal. Disponible tambien con LED SMD multi-chip a luz blanca natural.

Modelli depositati / Patent pending



Bianco



Ambra

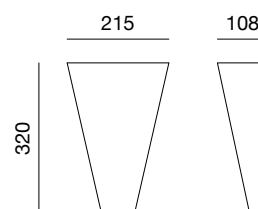
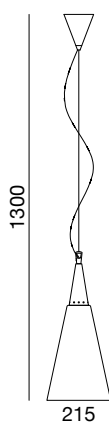
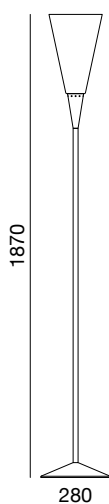

elettrificazione	colore	codice
1xE27 105W	Bianco	G2055.03
1xE27 105W	Ambra	G2055.04

dimmer



elettrificazione	colore	codice
1xE27 52W	Bianco	G2055.05
1xE27 52W	Ambra	G2055.06
LED SMD 15.4W 4500K	Bianco	G2055.15
LED SMD 15.4W 4500K	Ambra	G2055.16



elettrificazione	colore	codice
1xE27 52W	Bianco	G2055.01
1xE27 52W	Ambra	G2055.02
LED SMD 5.5W 4500K	Bianco	G2055.11
LED SMD 5.5W 4500K	Ambra	G2055.12



G2055.01



G2055.05

BIGLIA

Design Christian Pavanello

LED
SMD



Lampade a luce diffusa. Struttura in metallo cromato, diffusore in vetro soffiato satinato. Disponibile anche con illuminazione a LED SMD multi-chip a luce bianca naturale.

Lamps giving diffused light. Metal painted chrome frame, etched opal blown glass-diffuser. Also available with multi-chip SMD LED natural white light.



Lampen mit diffusem Licht. Struktur aus chrom lackiertem Metall, geblasenes satiniertes Glas. Die Leuchte ist auch mit LED SMD multi-chip erhältlich, weiß Tageslicht.



Collection de lampes à lumière diffuse. Structure en métal vernisé chromé, verre soufflé satiné. Le produit est aussi disponible dans la version avec LED SMD multi-chip, lumière blanche naturelle.

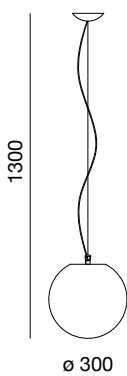
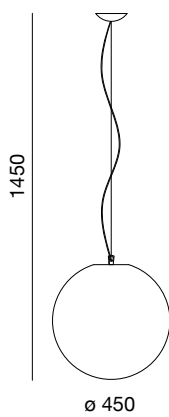

Luminaria de luz difusa. Estructura de metal cromado, difusor de cristal soplado satinado. Disponible tambien con LED SMD multi-chip a luz blanca natural.



Modelli depositati / Patent pending







elettrificazione	colore	codice
2xE27 42W  	Satinato	M104.4
1xLED SMD 15W 4500K	Satinato	M104.14



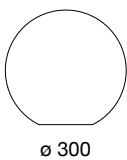
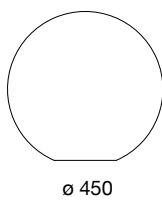

IP 20   

elettrificazione	colore	codice
1xE27 52W  	Satinato	M104.3
1xLED SMD 9W 4500K	Satinato	M104.13



IP 20   



elettrificazione	colore	codice
2xE27 42W  	Satinato	M104.6
+1xE27 42W 		

IP 20    

elettrificazione	colore	codice
1xE27 52W  	Satinato	M104.5

IP 20    



M104.6





M104.5

SURO

Design Ufficio Tecnico

Lampade a luce diffusa. Struttura in metallo cromato, diffusore in vetro soffiato satinato.

Lamps giving diffused light. Metal painted chrome frame, etched opal blown glass-diffuser.





Lampen mit diffusem Licht. Struktur aus chrom lackiertem Metall, geblasenes satinier-tes Glas.

Collection de lampes à lumière diffuse. Structure en métal vernisé chromé, verre soufflé satiné.

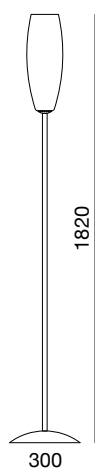
Luminaria de luz difusa. Estructura de metal cromado, difusor de cristal soplado satinado.

Modelli depositati / Patent pending





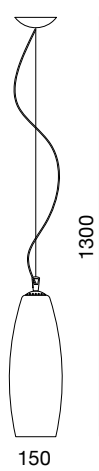

elettrificazione	colore	codice
1xE27 250W 	Satinato	M131.4
dimmer	   	

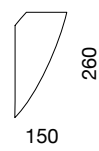

elettrificazione	colore	codice
1xE27 52W  	Satinato	M131.6
	   	



elettrificazione	colore	codice
1xE27 52W 	Satinato	M131.2
	   	







M131.4

SOFT

Design Ufficio Tecnico

Serie di lampade a luce diffusa da parete, da soffitto o da tavolo. Diffusore in vetro opale satinato. Struttura in metallo nickel spazzolato.

Range of wall, ceiling, pendant and table luminaires with diffuse light. Opal satin glass diffuser. Metal nickel brushed frame.

Kollektion von Wand-, Decken-, Pendel- und Tischleuchten mit diffusem Licht. Diffusor aus Opalsatinierem Glas. Struktur Nickel gebürstet.

Collection d'appliques, plafonniers, suspensions et lampes à poser. Diffuseur en verre opale satiné. Structure en métal nickel brossé.

Serie de luminarias de luz difusa de pared, de techo o de pié. Difusor de cristal opal satinado. La estructura metálica es en níquel bruñido.

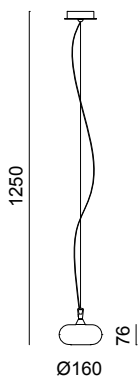

elettrificazione	colore	codice
1xG9 48W	Bianco	M125.03

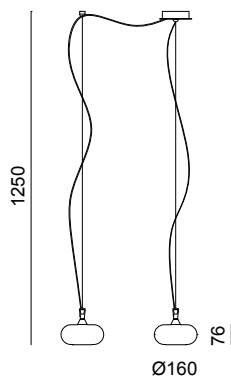

elettrificazione	colore	codice
2xG9 48W	Bianco	M125.04

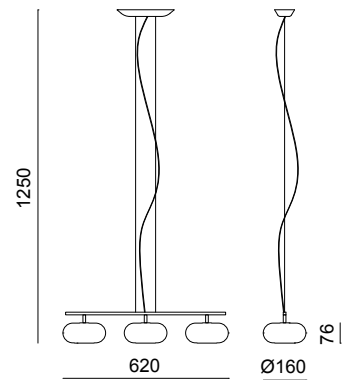

elettrificazione	colore	codice
3xG9 48W	Bianco	M125.05



elettrificazione	colore	codice
1xG9 48W	Bianco	M125.01



elettrificazione	colore	codice
1xG9 48W	Bianco	M125.06



elettrificazione	colore	codice
1xG9 48W	Bianco	M125.08



M125.08



M125.01



M125.05



ALBA

Lampade a luce diffusa. Il diffusore è in vetro soffiato opalino satinato, struttura in metallo verniciato, supporto in legno di ciliegio o verniciato alluminio. Predisposta per la doppia accensione.

Lamps giving diffused light. Etched opal blown glass diffuser, frame made of painted metal, base in cherry wood or painted aluminium. Pre-wired for double switch.

Lampen mit diffusem Licht. Diffusor aus geblasenem und satiniertem Opalglas, Struktur aus lackiertem Metall, Basis aus Kirschholz oder aus lackiertem Aluminium. Ausgestattet für Doppel-Zündung.

Lampes à lumière diffuse. Diffuseur en verre opale satiné, structure en métal vernisé, base en bois de cerisier ou aluminium vernisé. Prédiposé avec double allumage.

Luminaria de luz difusa. El difusor es de cristal soplado opal satinado, estructura de metal pintado, soporte de madera ó pintado aluminio. Preparada para doble encendido.

Modelli depositati / Patent pending



Alluminio



Ciliegio

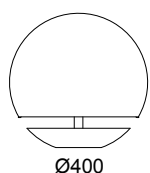

Ø400

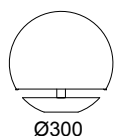

Ø300



Ø200

elettrificazione	colore	codice
1xE27 52W + 3xE14 28W	Alluminio	M100.5
1xE27 52W + 3xE14 28W	Ciliegio	M100.6

IP 20 V CE

elettrificazione	colore	codice
1xE27 42W	Alluminio	M100.3
1xE27 42W	Ciliegio	M100.4

IP 20 V CE

elettrificazione	colore	codice
1xE14 28W	Alluminio	M100.1
1xE14 28W	Ciliegio	M100.2

IP 20 V CE

M100.6

M100.4



M100.2

MARANGONA

Design Ufficio Tecnico

LED
SMD



Serie di lampade a luce diffusa a sospensione, parete e tavolo. Struttura in metallo verniciato, reggivetri cromati. Il diffusore di forma conica è in vetro, disponibile in bianco satinato, damascato bianco o decorato in foglia oro. Disponibile anche con illuminazione a LED SMD multi-chip a luce bianca naturale.

Collection of pendant, wall and table lamps giving diffuse lighting. Body made in painted metal with chromed glassholders. The cone shaped diffuser is in glass available in satin white, damask design or with gold foil. Also available with multi-chip SMD LED natural white light.

Kollektion von Hänge-, Wand- und Tischleuchten für diffuse Lichtverteilung. Struktur aus Metall lackiert und Metallteile verchromt. Das konische Glas ist erhältlich in weiß satiniert, in der Ausführung damast oder blattvergoldet. Die Leuchte ist auch mit LED SMD multi-chip erhältlich, weiß Tageslicht.

Collection de suspensions, appliques et lampes à poser pour éclairage diffuse. Structure en métal vernisé et supports chromés. Le diffuseur à la forme conique est disponible en blanc satiné, damassé ou en feuille d'or. Le produit est aussi disponible dans la version avec LED SMD multi-chip, lumière blanche naturelle.

Serie de lámparas de luz directa de suspensión, pared y de mesa. Estructura de metal pintado, difusor en forma cónica en cristal satinado, disponible con decoración damascado y en pan de oro. Disponible también con LED SMD multi-chip a luz blanca natural.



bianco



foglia oro

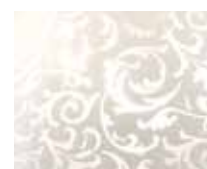

Damascato bianco

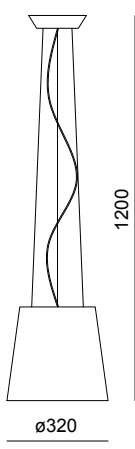
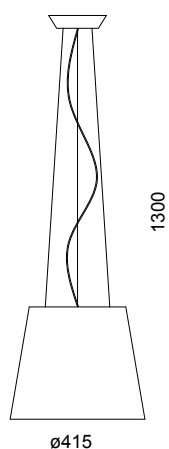

elettrificazione	colore	codice
3xE27 42W	Bianco	M119.7
3xE27 42W	Foglia Oro	M119.17
3xE27 42W	Damascato	M119.27
1xLED SMD 19W 4500K	Bianco	M119.47
1xLED SMD 19W 4500K	Foglia Oro	M119.57
1xLED SMD 19W 4500K	Damascato	M119.67

IP 20 V E CE

elettrificazione	colore	codice
1xE27 70W	Bianco	M119.8
1xE27 70W	Foglia Oro	M119.18
1xE27 70W	Damascato	M119.28
1xLED SMD 15W 4500K	Bianco	M119.48
1xLED SMD 15W 4500K	Foglia Oro	M119.58
1xLED SMD 15W 4500K	Damascato	M119.68

IP 20 V E CE

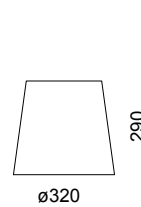
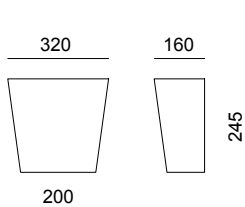
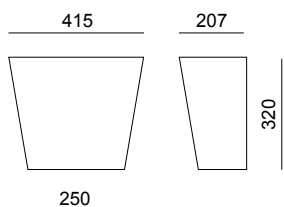

elettrificazione	colore	codice
2xE27 42W	Bianco	M119.10
2xE27 42W	Foglia Oro	M119.20
2xE27 42W	Damascato	M119.30
LED SMD 15.4W 4500K	Bianco	M119.50
LED SMD 15.4W 4500K	Foglia Oro	M119.60
LED SMD 15.4W 4500K	Damascato	M119.70

IP 20 V E CE

elettrificazione	colore	codice
1xE27 70W	Bianco	M119.11
1xE27 70W	Foglia Oro	M119.21
1xE27 70W	Damascato	M119.31
LED SMD 11W 4500K	Bianco	M119.51
LED SMD 11W 4500K	Foglia Oro	M119.61
LED SMD 11W 4500K	Damascato	M119.71

IP 20 V E CE

elettrificazione	colore	codice
1xE27 70W	Bianco	M119.9
1xE27 70W	Foglia Oro	M119.19
1xE27 70W	Damascato	M119.29
1xLED SMD 15W 4500K	Bianco	M119.49
1xLED SMD 15W 4500K	Foglia Oro	M119.59
1xLED SMD 15W 4500K	Damascato	M119.69

IP 20 V E CE





M119.9



BRICOLA

Design Ufficio Tecnico

LED
SMD



Lampade a luce diffusa. Il diffusore è in vetro soffiato opalino satinato, struttura e particolari in metallo cromato. Sospensione dotata di cavo in acciaio con micro-regolatore. Disponibile anche con illuminazione a LED SMD multi-chip a luce bianca naturale.

Lamps giving diffused lights. Etched opal blown glass diffuser, frame made of chromiumplated metal. Pendant with steel wire and micro regulation. Also available with multi-chip SMD LED natural white light.

Lampen mit diffusem Licht. Diffusor aus geblasenem und satiniertem Opalglas, Struktur aus verchromtem Metall. Die Leuchte ist auch mit LED SMD multi-chip erhältlich, weiß Tageslicht.

Collections de lampes à lumière diffuse. Le diffuseur est en verre opale satiné, structure et détails en métal chromé. La suspension est fournie avec câble en acier avec microrégulateur. Le produit est aussi disponible dans la version avec LED SMD multi-chip, lumière blanche naturelle.

Luminaria de techo, de pared, de apoyo y de pie de luz difusa. Difusor de cristal soplado opal satinado, estructura de metal con acabado cromo brillante. Disponible tambien con LED SMD multi-chip a luz blanca natural.



Cromo



Nichel spazzolato

Modelli depositati / Patent pending

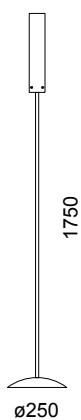

elettrificazione	finitura	codice
1xE27 70W	Cromo	M105.4
1xE27 70W	Nichel sp.	M105.14

dimmer



elettrificazione	finitura	codice
1xE27 52W	Cromo	M105.6
1xE27 52W	Nichel sp.	M105.16

LED SMD 15.4W 4500K Cromo M105.26
LED SMD 15.4W 4500K Nichel sp. M105.36

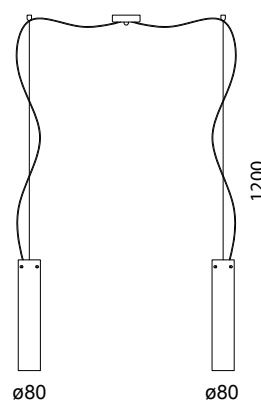

elettrificazione	finitura	codice
2xE27 52W	Cromo	M105.7
2xE27 52W	Nichel sp.	M105.17

2xLED SMD 15.4W 4500K Cromo M105.27
2xLED SMD 15.4W 4500K Nichel sp. M105.37



elettrificazione	finitura	codice
1xE27 52W	Cromo	M105.1
1xE27 52W	Nichel sp.	M105.11

LED SMD 15.4W 4500K Cromo M105.21
LED SMD 15.4W 4500K Nichel sp. M105.31

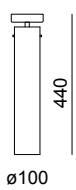

elettrificazione	finitura	codice
1xE27 42W	Cromo	M105.5
1xE27 42W	Nichel sp.	M105.15

LED SMD 15.4W 4500K Cromo M105.25
LED SMD 15.4W 4500K Nichel sp. M105.35

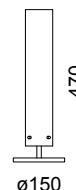

elettrificazione	finitura	codice
1xE27 52W	Cromo	M105.3
1xE27 52W	Nichel sp.	M105.13





M105.4







CIPOLLONA

Design Ufficio Tecnico

LED
SMD



Lampade a luce diffusa. Struttura in metallo verniciato, diffusore in vetro soffiato opalino satinato. Disponibile anche con illuminazione a LED SMD multi-chip a luce bianca naturale.

Lamps giving diffused light. Metal painted frame, etched opal blown glass-diffuser. Also available with multi-chip SMD LED natural white light.

Lampen mit diffusem Licht. Struktur aus lackiertem Metall, geblasenes opal-satiniertes Glas. Die Leuchte ist auch mit LED SMD multi-chip erhältlich, weiß Tageslicht.

Collection de lampes à lumière diffuse. Structure en métal vernisé, verre soufflé opale satiné. Le produit est aussi disponible dans la version avec LED SMD multi-chip, lumière blanche naturelle.

Luminaria de luz difusa. Estructura de metal pintado, difusor de cristal soplado opal satinado. Disponible tambien con LED SMD multi-chip a luz blanca natural.

Modelli depositati / Patent pending

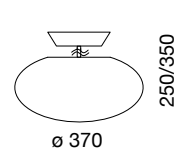
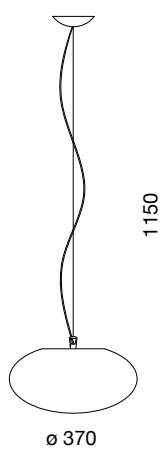
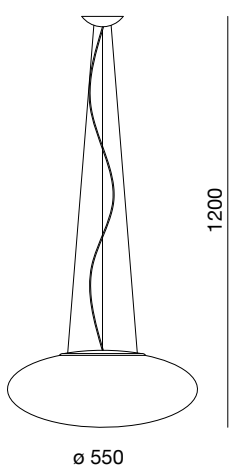

elettrificazione	colore	codice
3xE27 42W 	Satinato	M108.3
1xLED SMD 19W 4500K	Satinato	M108.6

IP 20   

elettrificazione	colore	codice
2xE27 42W 	Satinato	M108.1
1xLED SMD 15W 4500K	Satinato	M108.4

IP 20   

elettrificazione	colore	codice
2xE27 42W 	Satinato	M108.2
1xLED SMD 15W 4500K	Satinato	M108.5

IP 20   







M108.2

CUBO

Design Ufficio Tecnico

Lampade a luce diffusa in vetro soffiato opale satinato. Struttura in metallo con finitura nichel spazzolato.





Lamps giving diffused light with etched opal blown glass-diffuser. Metal frame with nickel brushed parts.



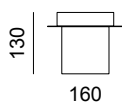
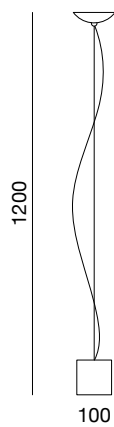

Lampen mit diffusem Licht mit geblasenem Glas-Diffusor opal-satiniert. Struktur aus Metall und Teile Nickel gebürstet.

Collection de lampes à lumière diffuse avec diffuseur en verre soufflé opale satiné. Structure en métal avec détails en nickel satiné.

Luminaria de luz difusa de cristal soplado opal satinado. Estructura de metal con acabado níque.



elettrificazione	colore	codice
1xG9 33W 	Bianco	G1086.03
	   	

elettrificazione	colore	codice
1xG9 33W 	Bianco	G1086.01
	   	



SFERA

Design Ufficio Tecnico

Lampade a luce diffusa. Struttura in metallo nichel spazzolato, diffusore in vetro soffiato opale satinato.

Lamps giving diffused light. Metal frame nickel brushed, etched opal blown glass-diffuser.

Lampen mit diffusem Licht. Struktur aus Metall nickel gebürstet, geblasener Glas-Diffusor opal-satiniert.

Collection de lampes à lumière diffuse. Structure en métal nickel satiné. Diffuseur en verre soufflé opale satiné.

Luminaria de luz difusa. Estructura de metal níquel bruñido, difusor de cristal soplado opal satinado.

Modelli depositati / Patent pending



Blu



Ambra



Bianco



Nero

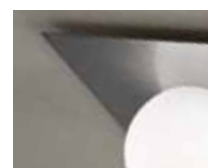

Grigio

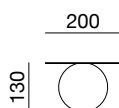

elettrificazione	colore	codice
1xG9 33W	Blu	G1093.05
1xG9 33W	Ambra	G1093.06
1xG9 33W	Bianco	G1093.09
1xG9 33W	Nero	G1093.10
1xG9 33W	Grigio	G1093.11

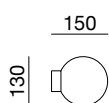

elettrificazione	colore	codice
1xG9 33W	Bianco	G1093.04

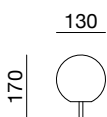

elettrificazione	colore	codice
1xG9 33W	Bianco	G1093.08

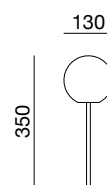
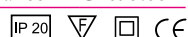

elettrificazione	colore	codice
1xG9 33W	Bianco	G1093.07

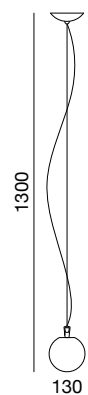

elettrificazione	colore	codice
1xG9 33W	Bianco	G1093.01

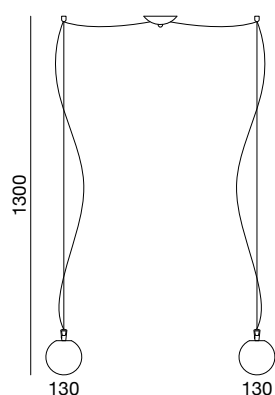

elettrificazione	colore	codice
2xG9 33W	Bianco	G1093.02

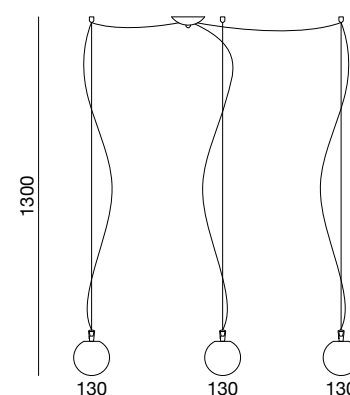

elettrificazione	colore	codice
3xG9 33W	Bianco	G1093.03







G1093.05

G1093.04



G1093.01

G1093.08

G1093.07



G1093.10

G1093.09



G1093.11

BOLLA

Design Ufficio Tecnico

Lampade a luce diffusa. Struttura in metallo cromato, diffusore in vetro soffiato satinato.

Lamps giving diffused light. Chromed metal frame, etched opal blown glass diffuser.

Lampen mit diffusem Licht. Struktur aus verchromtem Metall, geblasener Glas-Diffusor satiniert.

Collection de lampes à lumière diffuse. Structure en métal chromé. Diffuseur en verre soufflé satiné.

Luminaria de luz difusa. Estructura de metal cromado, difusor de cristal soplado satinado.

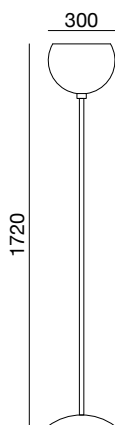

elettrificazione	colore	codice
1xE27 105W	Bianco	G1131.10
dimmer		

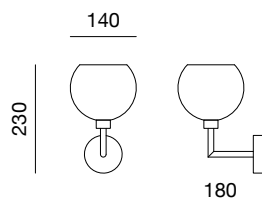

elettrificazione	colore	codice
1xE14 42W	Bianco	G1131.11

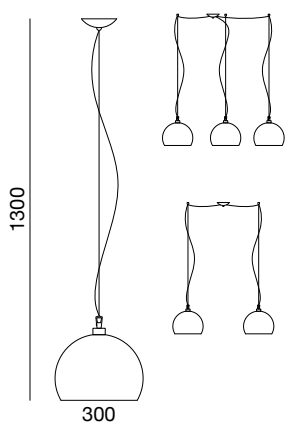

elettrificazione	colore	codice
1xE27 52W	Bianco	G1131.01
2xE27 52W	Bianco	G1131.02
3xE27 52W	Bianco	G1131.03

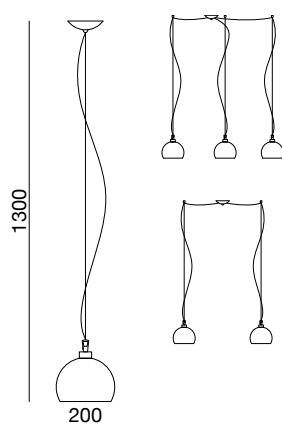

elettrificazione	colore	codice
1xE27 52W	Bianco	G1131.04
2xE27 52W	Bianco	G1131.05
3xE27 52W	Bianco	G1131.06

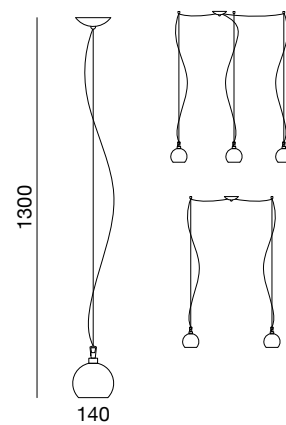

elettrificazione	colore	codice
1xE14 42W	Bianco	G1131.07
2xE14 42W	Bianco	G1131.08
3xE14 42W	Bianco	G1131.09





G1131.05

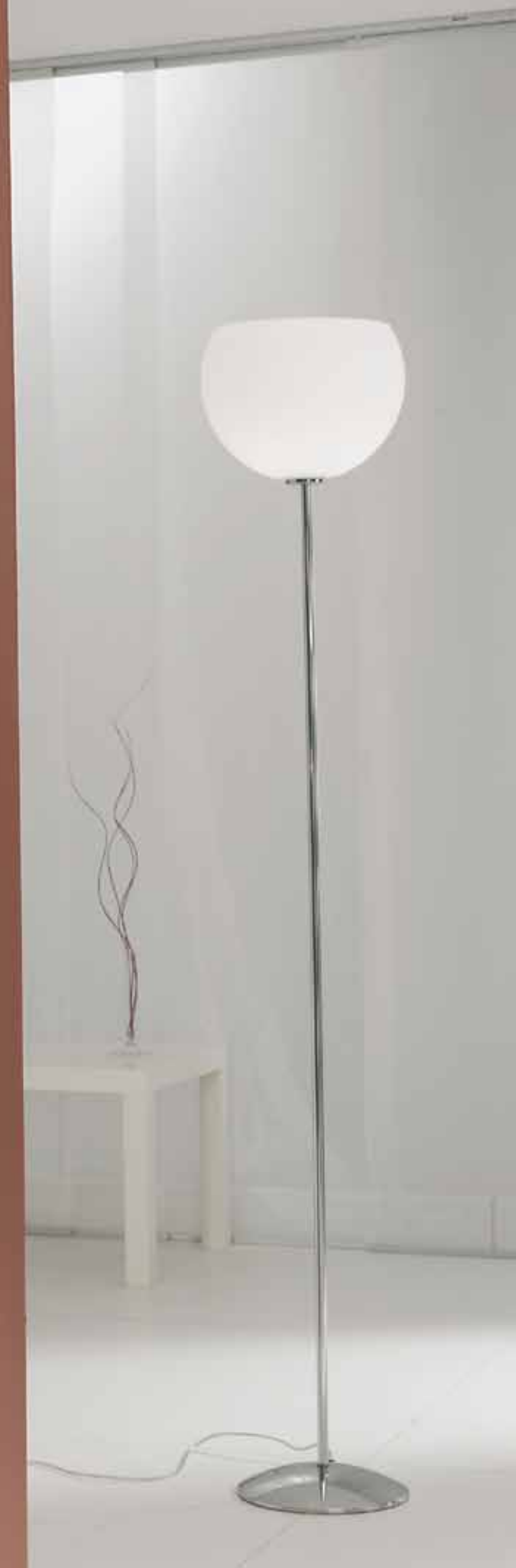

BOLLE

Design Ufficio Tecnico

Serie di lampade a luce diffusa. Struttura in metallo cromato, vetro soffiato satinato.

Lamps giving diffused light. Chromed metal frame, etched opal blown glass diffuser.

Lampen mit diffusem Licht. Struktur aus verchromtem Metall, geblasener Glas-Diffusor satiniert.

Collection de lampes à lumière diffuse. Structure en métal chromé. Diffuseur en verre soufflé satiné.

Serie de aparatos de luz difusa. Estructura de metal cromado, cristal soplado satinado.

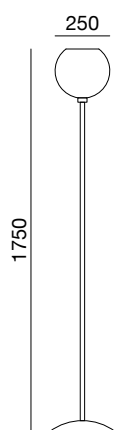

elettrificazione	colore	codice
1xE27 105W		Trasp.+Satin. G1085.13
dimmer		

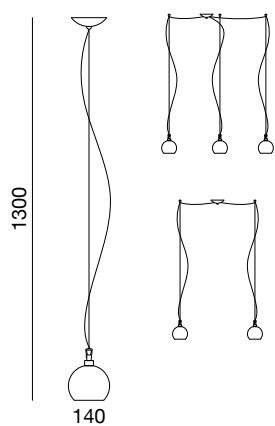

elettrificazione	colore	codice
1xE14 42W		Trasp.+Satin. G1085.01
2xE14 42W		Trasp.+Satin. G1085.09
3xE14 42W		Trasp.+Satin. G1085.10

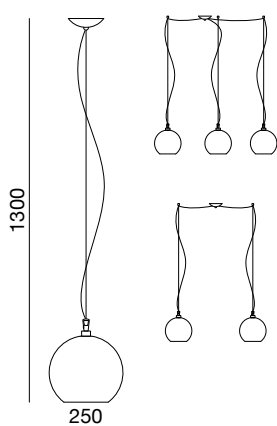

elettrificazione	colore	codice
1xE27 52W		Trasp.+Satin. G1085.02
2xE27 52W		Trasp.+Satin. G1085.11
3xE27 52W		Trasp.+Satin. G1085.12

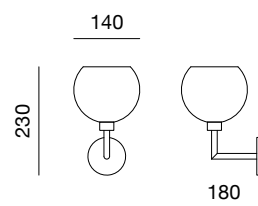

elettrificazione	colore	codice
1xE14 42W		Trasp.+Satin. G1085.14

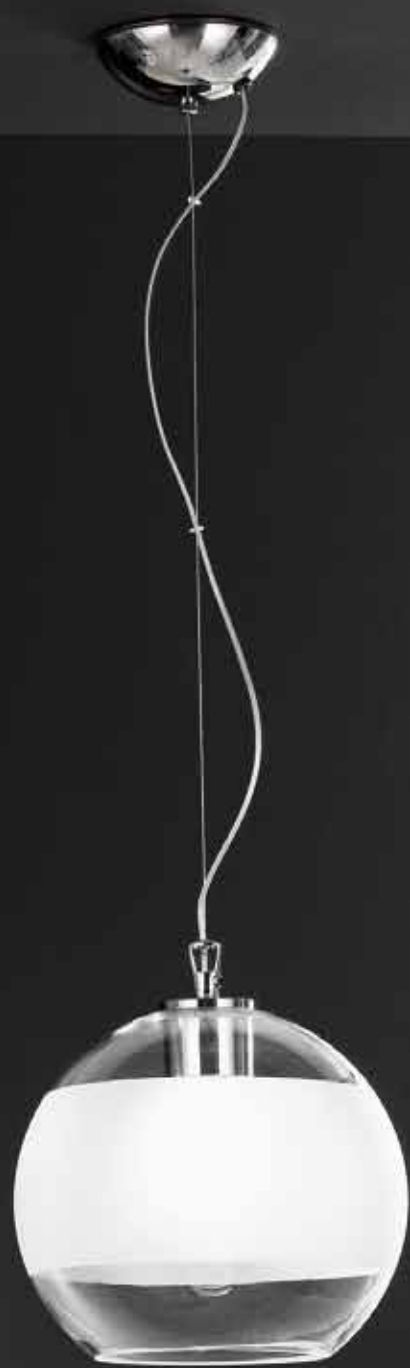
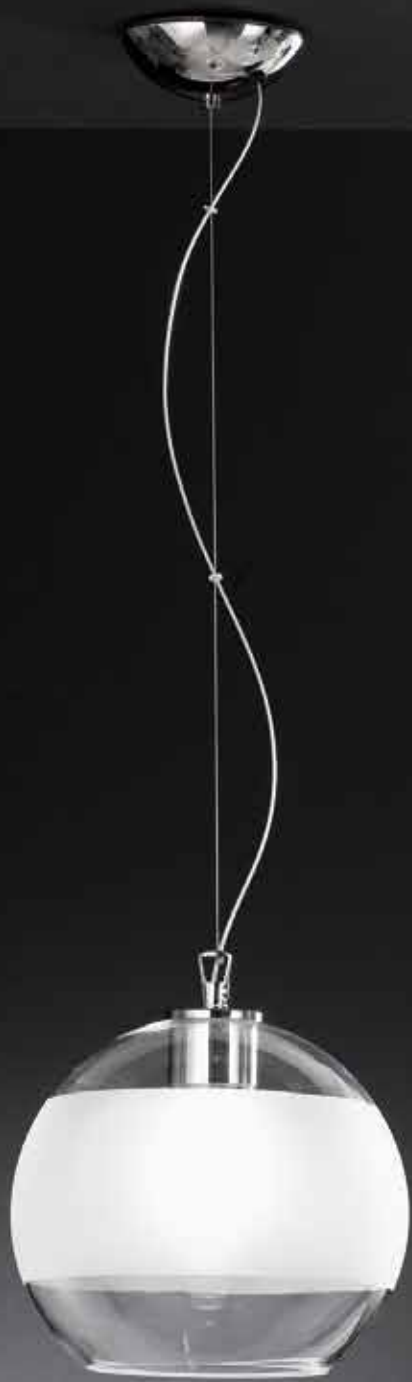



G1085.10



TUBA

Design Ufficio Tecnico

LED
SMD



Lampade a luce diffusa in vetro soffiato opale satinato. Struttura in metallo con finitura nichel spazzolato. Disponibile anche con illuminazione a LED SMD multi-chip a luce bianca naturale.

Lamps giving diffused light. Chromed metal frame, etched opal blown glass diffuser. Also available with multi-chip SMD LED natural white light.

Lampen mit diffusem Licht. Struktur aus verchromtem Metall, geblasener Glas-Diffusor satiniert. Die Leuchte ist auch mit LED SMD multi-chip erhältlich, weiß Tageslicht.

Collection de lampes à lumière diffuse. Structure en métal chromé. Diffuseur en verre soufflé satiné. Le produit est aussi disponible dans la version avec LED SMD multi-chip, lumière blanche naturelle.

Luminaria de luz difusa, cristal soplado opal satinado. Estructura de metal con acabado níquel. Disponible tambien con LED SMD multi-chip a luz blanca natural.



Bianco



Ambra

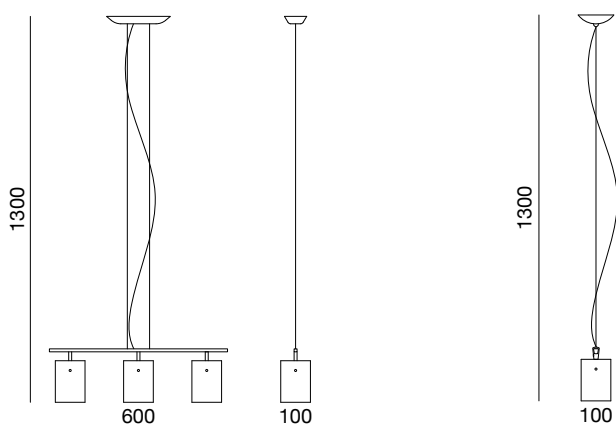

elettrificazione		colore	codice
3xG9 48W		Bianco	G2030.07
3xG9 48W		Ambra	G2030.08
3xLED SMD 2.9W 4500K		Bianco	G2030.17
3xLED SMD 2.9W 4500K		Ambra	G2030.18

IP 20

elettrificazione		colore	codice
1xG9 48W		Bianco	G2030.09
1xG9 48W		Ambra	G2030.10
1xLED SMD 2.9W 4500K		Bianco	G2030.19
1xLED SMD 2.9W 4500K		Ambra	G2030.20

IP 20

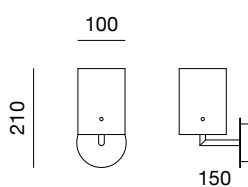

elettrificazione		colore	codice
1xG9 48W		Bianco	G2030.01
1xG9 48W		Ambra	G2030.02
1xLED SMD 2.9W 4500K		Bianco	G2030.11
1xLED SMD 2.9W 4500K		Ambra	G2030.12

IP 20

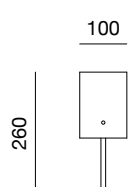

elettrificazione		colore	codice
1xG9 48W		Bianco	G2030.03
1xG9 48W		Ambra	G2030.04

IP 20

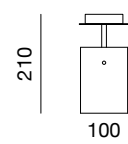

elettrificazione		colore	codice
1xG9 48W		Bianco	G2030.05
1xG9 48W		Ambra	G2030.06
1xLED SMD 2.9W 4500K		Bianco	G2030.15
1xLED SMD 2.9W 4500K		Ambra	G2030.16

IP 20



G2030.07



G2030.03



G2030.05

G2030.01

FOGLIA

Design Ufficio Tecnico

Lampade a luce diffusa. Struttura in metallo cromato, diffusore in vetro soffiato con foglia oro 24k o foglia argento.

Lamps giving diffused light. Chromed metal frame, blown glass diffuser with 24K gold or silver foil.

Lampen mit diffusem Licht. Struktur aus verchromtem Metall, geblasener Glas-Diffusor mit Goldfolie 24k oder Silberfolie.

Collection de lampes à lumière diffuse. Structure en métal chromé. Diffuseur en verre soufflé avec feuille d'or 24k ou feuille d'argent.

Luminaria de luz difusa. Estructura de metal cromado, difusor de cristal soplado con baño de oro 24 K ó baño de plata.

Modelli depositati / Patent pending







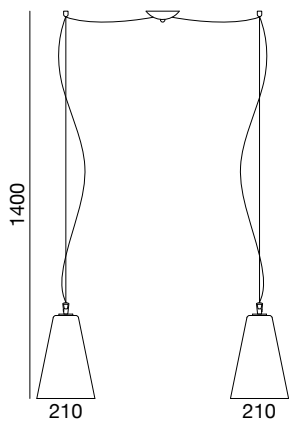

Foglia Argento





Foglia Oro



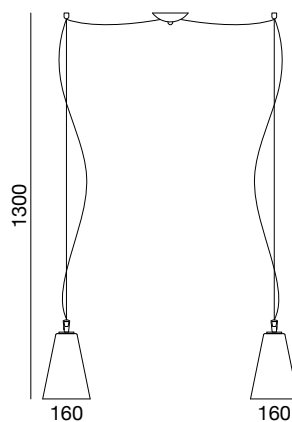

elettrificazione	finitura	codice
2xE27 42W  	Foglia Argento	G1091.04
2xE27 42W  	Foglia Oro	G1091.11



IP 20   



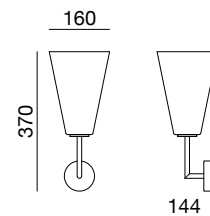

elettrificazione	finitura	codice
2xE27 42W 	Foglia Argento	G1091.03
2xE27 42W 	Foglia Oro	G1091.10



IP 20   



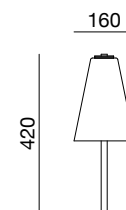

elettrificazione	finitura	codice
1xE27 70W 	Foglia Argento	G1091.05
1xE27 70W 	Foglia Oro	G1091.12



IP 20   



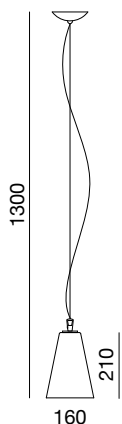

elettrificazione	finitura	codice
1xE14 42W 	Foglia Argento	G1091.06
1xE14 42W 	Foglia Oro	G1091.13





IP 20   



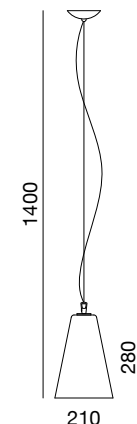

elettrificazione	finitura	codice
1xE27 52W 	Foglia Argento	G1091.01
1xE27 52W 	Foglia Oro	G1091.08



IP 20   



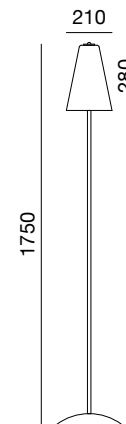

elettrificazione	finitura	codice
1xE27 52W  	Foglia Argento	G1091.02
1xE27 52W  	Foglia Oro	G1091.09

IP 20   



elettrificazione	finitura	codice
1xE27 70W 	Foglia Argento	G1091.07
1xE27 70W 	Foglia Oro	G1091.14

dimmer IP 20   





G1091.10

G1091.07

G1091.05



G1091.06



COOKI 5

Design Ufficio Tecnico

Lampada a luce diffusa. Struttura in metallo cromato, diffusore in vetro satinato.

Lamps giving diffused light. Chromed metal frame, satin glass diffuser.

Lampen mit diffusem Licht. Struktur aus verchromtem Metall, Glas-Diffusor satiniert.

Lampes à lumière diffuse. Structure en métal chromé. Diffuseur en verre satiné.

Luminaria de luz difusa. Estructura de metal cromado, difusor de cristal satinado.

Modelli depositati / Patent pending





Trasparente



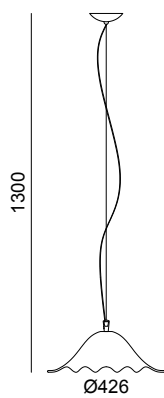
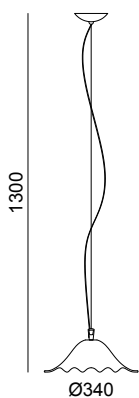

Ambra



elettrificazione	colore	codice
1xE27 52W	 Trasparente	G0629.01
1xE27 52W	 Ambra	G0629.03



elettrificazione	colore	codice
1xE27 52W	 Trasparente	G0629.02
1xE27 52W	 Ambra	G0629.04



G0629.01

G0629.04



RELAX

Design Ufficio Tecnico

Lampada a luce diffusa. Struttura in metallo cromato. Diffusore in vetro satinato e trasparente.

Lamps giving diffused light. Chromed metal frame, satin and transparent glass diffuser.

Lampen mit diffusem Licht. Struktur aus verchromtem Metall, Glas Diffusor satiniert und transparent.

Lampes à lumière diffuse. Structure en métal chromé. Diffuseur en verre satiné et transparent.

Luminaria de luz difusa. Estructura de metal cromado. Difusor de cristal satinado y transparente.



G2055.01



elettrificazione	finitura	codice
1xG9 20W	Cromo	G2040.01
	IP 20	VF
	⊕	CE

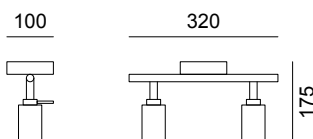

elettrificazione	finitura	codice
2xG9 20W	Cromo	G2040.02
	IP 20	VF
	⊕	CE

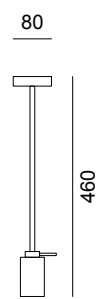

elettrificazione	finitura	codice
1xG9 20W	Cromo	G2040.07
	IP 20	VF
	⊕	CE



G2040.02

OVALE

Design Ufficio Tecnico

LED
SMD



Lampada a luce diffusa. Struttura in metallo nichel spazzolato, paralume in tessuto cotonette beige. Disponibile anche con illuminazione a LED SMD multi-chip a luce bianca naturale.

Lamps giving diffused light. Metal frame available in brushed nickel, beige fabric lampshade. Also available with multi-chip SMD LED natural white light.

Lampen mit diffusem Licht. Struktur aus nickel gebürstetem Metall, Textil Diffusor sandfarbig. Die Leuchte ist auch mit LED SMD multi-chip erhältlich, weiß Tageslicht.

Lampes à lumière diffuse. Structure en nickel brossé. Diffuseur textile beige. Le produit est aussi disponible dans la version avec LED SMD multi-chip, lumière blanche naturelle.

Luminaria de luz difusa. Estructura de metal niquelado bruñido, pantalla textil beige. Disponible tambien con LED SMD multi-chip a luz blanca natural.

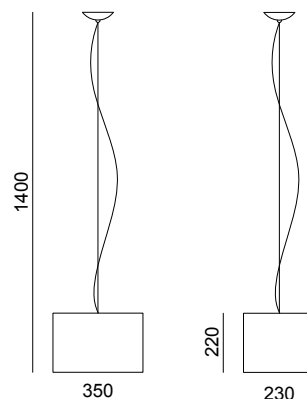
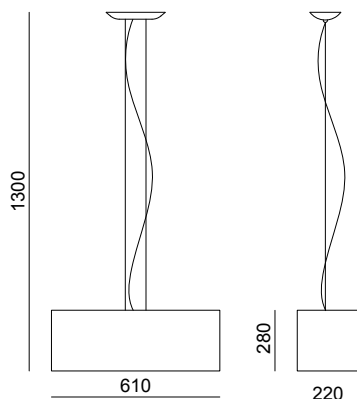
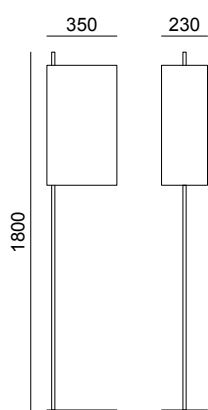

elettrificazione	colore	codice
1xE27 70W	Beige	G1204.03



elettrificazione	colore	codice
2xE27 42W	Beige	G1204.02
LED SMD 15.4W 4500K	Beige	G1204.52



elettrificazione	colore	codice
1xE27 42W	Beige	G1204.05
LED SMD 7.7W 4500K	Beige	G1204.55

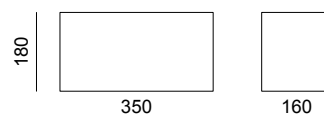
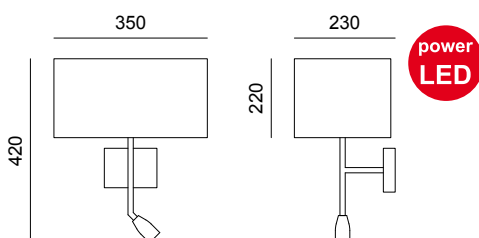
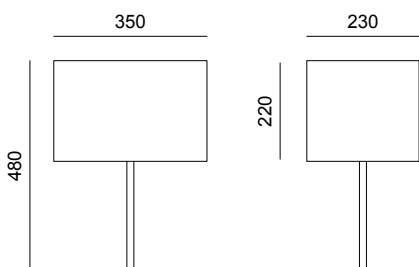

elettrificazione	colore	codice
1xE27 42W	Beige	G1204.04



elettrificazione	colore	codice
1xE27 42W	Beige	G1204.06
+1xLED 1.2W 350mA		
LED SMD 7.7W 4500K	Beige	G1204.56
+1xLED 1.2W 350mA		



elettrificazione	colore	codice
1xE27 42W	Beige	G1204.01
LED SMD 7.7W 4500K	Beige	G1204.51









QUADRA

Design Ufficio Tecnico

LED
SMD



Lampada a luce diffusa. Struttura in metallo nichel spazzolato, paralume in tessuto cotonette beige. Disponibile anche con illuminazione a LED SMD multi-chip a luce bianca naturale.

Lamps giving diffused light. Nickel brushed metal frame, beige fabric lampshade. Also available with multi-chip SMD LED natural white light.

Lampen mit diffusem Licht. Struktur aus nickel gebürstetem Metall, Textil Diffusor sandfarbig. Die Leuchte ist auch mit LED SMD multi-chip erhältlich, weiß Tageslicht.

Lampes à lumière diffuse. Structure en nickel brossé. Diffuseur textile beige. Le produit est aussi disponible dans la version avec LED SMD multi-chip, lumière blanche naturelle.

Luminaria de luz difusa. Estructura de metal niquelado bruñido, pantalla textil beige. Disponible también con LED SMD multi-chip a luz blanca natural.

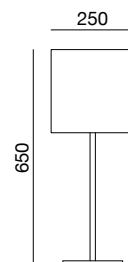
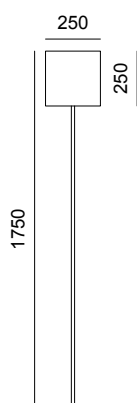
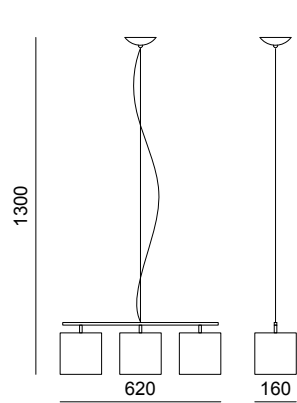

IP 20



elettrificazione	colore	codice
1xE27 70W	Beige	G1206.06
dimmer		

elettrificazione	colore	codice
1xE27 42W	Beige	G1206.04

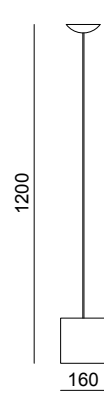
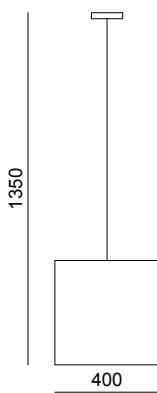
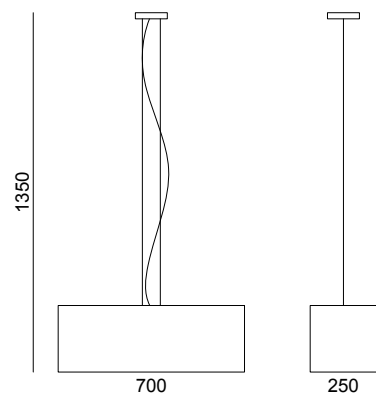

elettrificazione	colore	codice
2xE27 42W	Beige	G1206.10
LED SMD 15.4W 4500K	Beige	G1206.70

IP 20

elettrificazione	colore	codice
1xE27 70W	Beige	G1206.11
LED SMD 7.7W 4500K	Beige	G1206.71

IP 20

elettrificazione	colore	codice
1xE27 42W	Beige	G1206.05
LED SMD 4.4W 4500K	Beige	G1206.65

IP 20

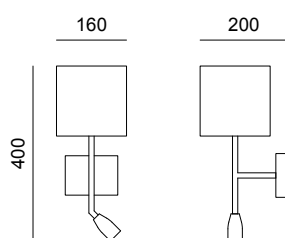
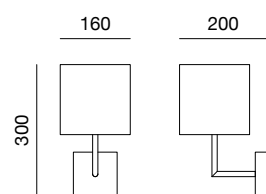

power
LED

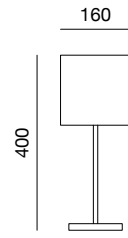

elettrificazione	colore	codice
1xE27 42W	Beige	G1206.01
LED SMD 4.4W 4500K	Beige	G1206.61

IP 20

elettrificazione	colore	codice
1xE27 42W	Beige	G1206.02
+1xLED 1.2W 350mA		
LED SMD 4.4W 4500K	Beige	G1206.62
+1xLED 1.2W 350mA		

IP 20

elettrificazione	colore	codice
1xE27 42W	Beige	G1206.03

IP 20





G1206.05

G1206.04

G1206.03





G1206.06



G1206.01



G1206.02

CONO

Design Ufficio Tecnico

Lampada a luce diffusa. Struttura in metallo nichel spazzolato, paralume in tessuto cotone bianco.

Lamps giving diffused light. Nickel brushed metal frame, white fabric lampshade.

Lampen mit diffusem Licht. Struktur aus nickel gebürstetem Metall, Textil Diffusor weiß.

Lampes à lumière diffuse. Structure en nickel brossé. Diffuseur textile blanc.

Luminaria de luz difusa. Estructura de metal niquelado bruñido, pantalla textil blanca.

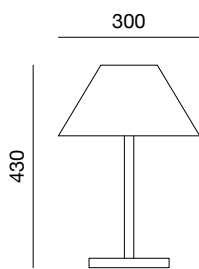
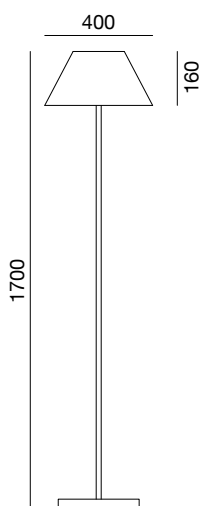

elettrificazione	colore	codice
1xE27 52W	Bianco	G1201.03

elettrificazione	colore	codice
	Bianco	G1201.02

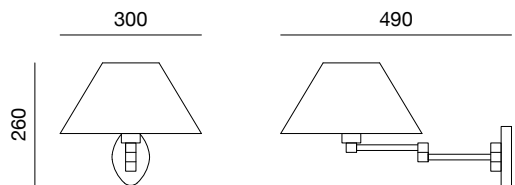
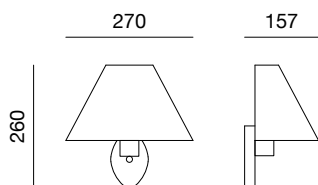

elettrificazione	colore	codice
1xE27 42W	Bianco	G1201.01

elettrificazione	colore	codice
1xE27 42W	Bianco	G1201.02

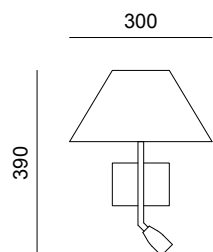

elettrificazione	colore	codice
1xE27 42W	Bianco	G1201.06
+1xLED 1.2W 350mA		



G1201.01



G1201.03



G1201.02



G1201.04



TONDO

Design Ufficio Tecnico

LED
SMD



Lampada a luce diffusa. Struttura in metallo nichel spazzolato, paralume in tessuto cotonette beige. Disponibile anche con illuminazione a LED SMD multi-chip a luce bianca naturale.

Lamps giving diffused light. Nickel brushed metal frame, beige fabric lampshade. Also available with multi-chip SMD LED natural white light.

Lampen mit diffusem Licht. Struktur aus nickel gebürstetem Metall, Textil Diffusor sandfarbig. Die Leuchte ist auch mit LED SMD multi-chip erhältlich, weiß Tageslicht.

Lampes à lumière diffuse. Structure en nickel brossé. Diffuseur textile beige. Le produit est aussi disponible dans la version avec LED SMD multi-chip, lumière blanche naturelle.

Luminaria de luz difusa. Estructura de metal niquelado bruñido, pantalla textil beige. Disponible tambien con LED SMD multi-chip a luz blanca natural.

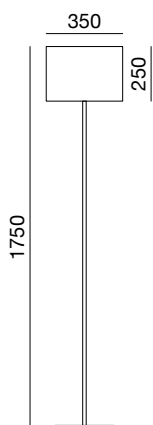

elettrificazione	colore	codice
1xE27 70W	Beige	G1207.06
dimmer		

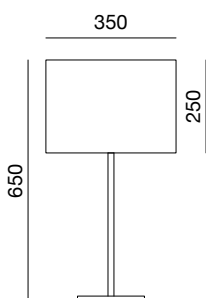

elettrificazione	colore	codice
1xE27 42W	Beige	G1207.04

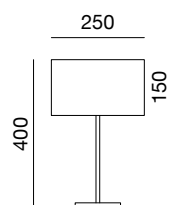

elettrificazione	colore	codice
1xE27 42W	Beige	G1207.03

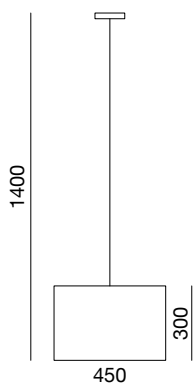

elettrificazione	colore	codice
1xE27 70W	Beige	G1207.05
1xLED SMD 9W 4500K	Beige	G1207.55

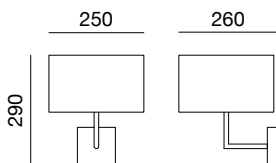

elettrificazione	colore	codice
1xE27 42W	Beige	G1207.01
1xLED SMD 2.9W 4500K	Beige	G1207.51

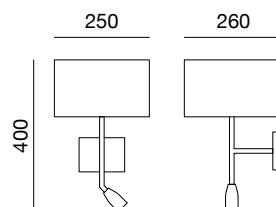

elettrificazione	colore	codice
1xE27 42W	Beige	G1207.02
+ 1xLED 1.2W 350mA		
1xLED SMD 2.9W 4500K	Beige	G1207.52
+ 1xLED 1.2W 350mA		

power
LED

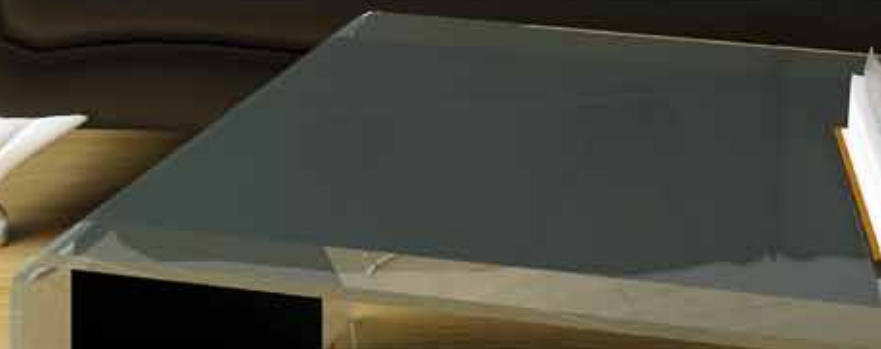

G1207.01



G1207.05

G1207.02



COPPO

Design Ufficio Tecnico

LED
SMD



Lampade a luce diffusa. Struttura in metallo verniciato. Diffusore in vetro satinato. Disponibile anche con illuminazione a LED SMD multi-chip a luce bianca naturale.

Lamps giving diffused light. Painted metal frame, glass diffuser satin. Also available with multi-chip SMD LED natural white light.

Lampen mit diffusem Licht. Struktur aus lackiertem Metall, Glas Diffusor satiniert. Die Leuchte ist auch mit LED SMD multi-chip erhältlich, weiß Tageslicht.

Lampes à lumière diffuse. Structure en métal vernisé. Diffuseur en verre satiné. Le produit est aussi disponible dans la version avec LED SMD multi-chip, lumière blanche naturelle.

Luminaria de luz difusa. Estructura de metal pintado. Difusor de cristal satinado. Disponible tambien con LED SMD multi-chip a luz blanca natural.



Bianco



Ambra



Multicolore



Bianco / Blu

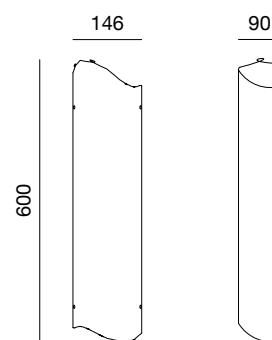
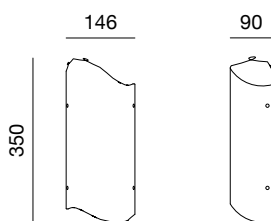
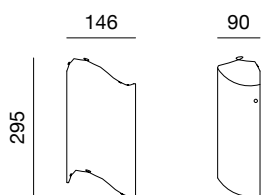

elettrificazione	colore	codice
1xE27 42W	Bianco	G0263.01
1xE27 42W	Multicolore	G0263.02
1xE27 42W	Bianco/Blu	G0263.03
1xLED SMD 2.9W 4500K	Bianco	G0263.21
1xLED SMD 2.9W 4500K	Multicolore	G0263.22
1xLED SMD 2.9W 4500K	Bianco/Blu	G0263.23

IP 20

elettrificazione	colore	codice
1xE27 42W	Bianco	G0263.04
1xG24q2 18W	Bianco	G0263.05
1xLED SMD 9W 4500K	Bianco	G0263.24
1xE27 42W	Ambra	G0263.08
1xG24q2 18W	Ambra	G0263.09
1xLED SMD 9W 4500K	Ambra	G0263.28

IP 20

elettrificazione	colore	codice
2xE27 42W	Bianco	G0263.06
1x2G11 24W	Bianco	G0263.07
2xLED SMD 9W 4500K	Bianco	G0263.26
2xE27 42W	Ambra	G0263.10
1x2G11 24W	Ambra	G0263.11
2xLED SMD 9W 4500K	Ambra	G0263.30

IP 20



G0263.01

G0263.08





G0263.10

PLICK 3

Design Ufficio Tecnico

LED
SMD



Lampada a luce diffusa. Struttura in metallo verniciato. Diffusore in vetro satinato, reggivetro in pressofusione. Disponibile anche con illuminazione a LED SMD multi-chip a luce bianca naturale.

Lamps giving diffused light. Painted metal frame, satin glass diffuser, die-cast glassholders. Also available with multi-chip SMD LED natural white light.

Lampen mit diffusem Licht. Struktur aus lackiertem Metall, Glas Diffusor satiniert. Glashalter aus Druckguß. Die Leuchte ist auch mit LED SMD multi-chip erhältlich, weiß Tageslicht.

Lampen à lumière diffuse. Structure en métal vernisé. Diffuseur en verre satiné, Supports du verre en laiton moulé. Le produit est aussi disponible dans la version avec LED SMD multi-chip, lumière blanche naturelle.

Luminaria de luz difusa. Estructura de metal pintado. Difusor de cristal satinado, fijador de fundición. Disponible tambien con LED SMD multi-chip a luz blanca natural.

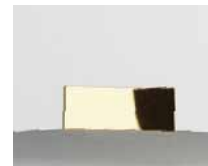

Oro



Cromo

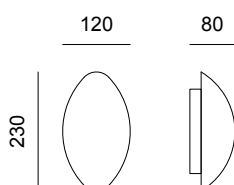

elettrificazione		finitura	codice
1xE27 42W		Oro	G0233.01
1xE27 42W		Cromo	G0233.02
1xLED SMD 2.9W 4500K		Oro	G0233.11
1xLED SMD 2.9W 4500K		Cromo	G0233.12





OCIO

Design Ufficio Tecnico

LED
SMD



Lampada a luce diffusa. Struttura in metallo verniciato. Anello in vetro di Murano, diffusore in vetro satinato. Disponibile anche con illuminazione a LED SMD multi-chip a luce bianca naturale.

Lamps giving diffused light. Painted metal frame, Murano glass ring, satin glass diffuser. Also available with multi-chip SMD LED natural white light.

Lampen mit diffusem Licht. Struktur aus lackiertem Metall, Murano Glas Ring, Glass Diffusor satiniert. Die Leuchte ist auch mit LED SMD multi-chip erhältlich, weiß Tageslicht.

Lampes à lumière diffuse. Structure en métal vernisé. Anneau en verre de Murano, diffuseur en verre satiné. Le produit est aussi disponible dans la version avec LED SMD multi-chip, lumière blanche naturelle.

Luminaria de luz difusa. Estructura de metal pintado. Anillo de cristal de Murano, difusor de cristal satinado. Disponible tambien con LED SMD multi-chip a luz blanca natural.



Cristallo

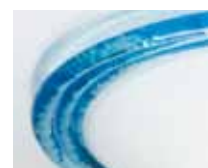

Azzurro

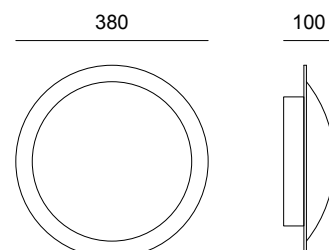
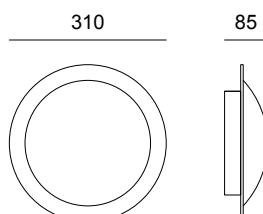
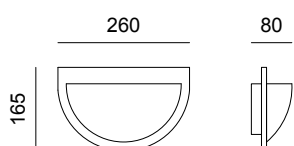

elettrificazione	colore	codice
1xE27 42W	Cristallo	G0248.01
1xE27 42W	Azzurro	G0248.02
1xLED SMD 2.9W 4500K	Cristallo	G0248.11
1xLED SMD 2.9W 4500K	Azzurro	G0248.12

IP 20

elettrificazione	colore	codice
1xE27 42W	Cristallo	G0248.03
1xLED SMD 9W 4500K	Cristallo	G0248.13

IP 20

elettrificazione	colore	codice
2xE27 42W	Cristallo	G0248.05
2xE27 42W	Azzurro	G0248.06
1xLED SMD 15W 4500K	Cristallo	G0248.15
1xLED SMD 15W 4500K	Azzurro	G0248.16

IP 20

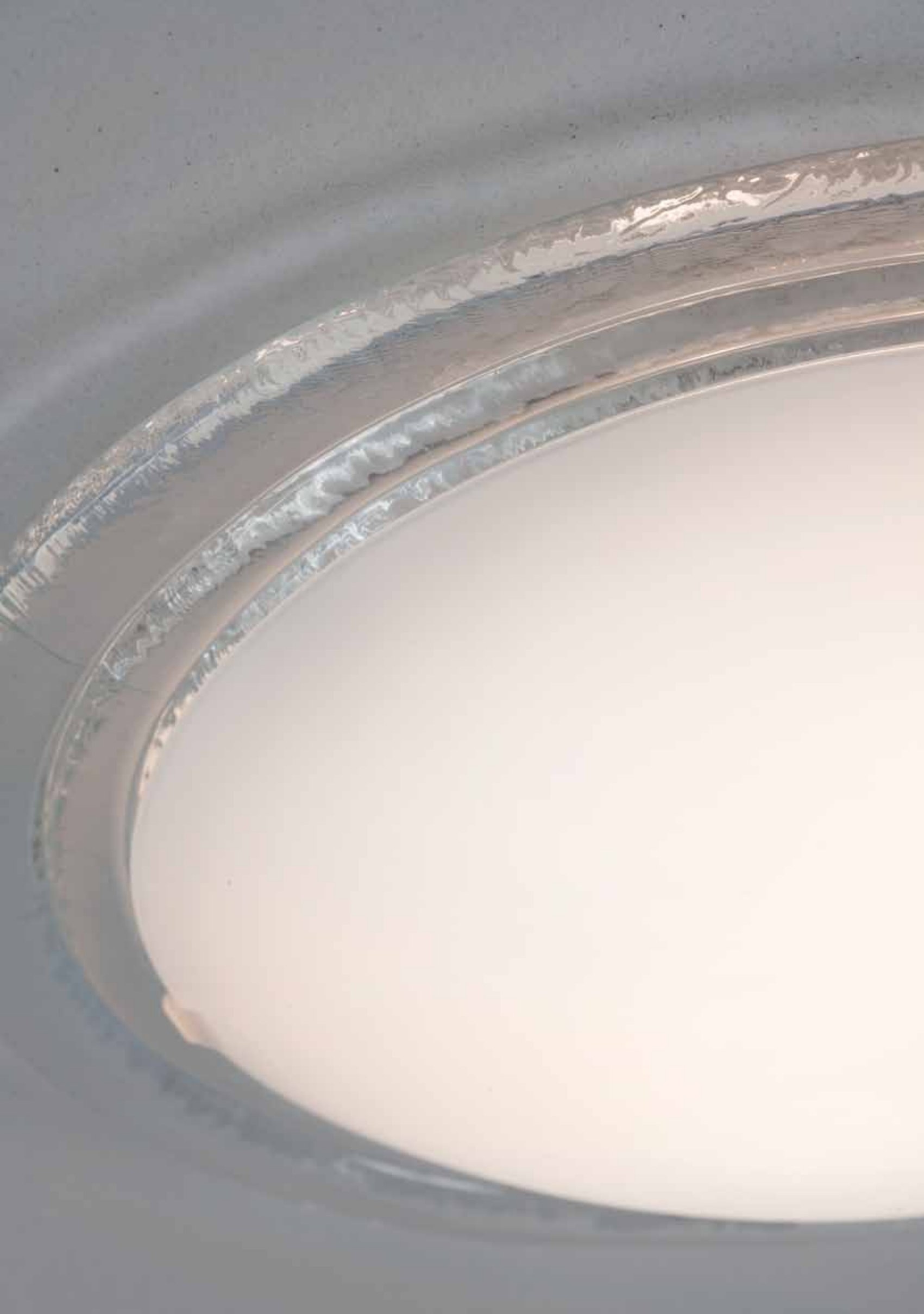





G0248.02

SMOOTH

Design Ufficio Tecnico

LED
SMD



Lampada a luce diffusa. Struttura in metallo verniciato. Reggivetri cromati/ottonati, vetro satinato bianco. Disponibile anche con illuminazione a LED SMD multi-chip a luce bianca naturale.

Lamps giving diffused light. Painted metal frame, chromed / brassed glassholders, white satin glass diffuser. Also available with multi-chip SMD LED natural white light.

Lampen mit diffusem Licht. Struktur aus lackiertem Metall, Glashalter verchromt oder vermessingt, Glas Diffusor weiß satiniert. Die Leuchte ist auch mit LED SMD multi-chip erhältlich, weiß Tageslicht.

Lampes à lumière diffuse. Structure en métal vernisé. Supports du verre chromé ou laiton, diffuseur en verre satiné blanc. Le produit est aussi disponible dans la version avec LED SMD multi-chip, lumière blanche naturelle.

Luminaria de luz difusa. Estructura de metal pintado. Fijación cromada/latonada, cristal satinado. Disponible tambien con LED SMD multi-chip a luz blanca natural.

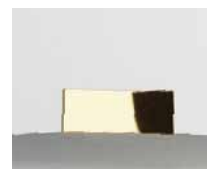

Oro

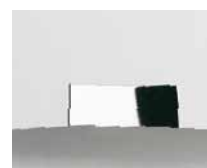

Cromo

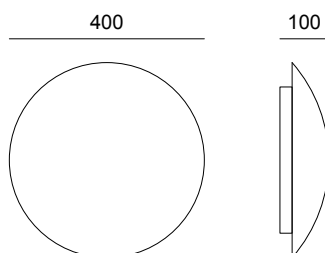
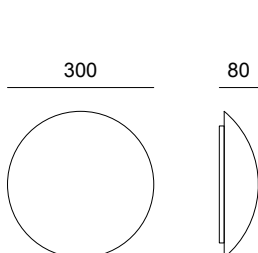

elettrificazione	finitura codice
1xE27 42W	Cromo G0244.01
1xLED SMD 9W 4500K	Cromo G0244.11



elettrificazione	finitura codice
2xE27 42W	Cromo G0244.05
2xE27 42W	Oro G0244.06
1xLED SMD 15W 4500K	Cromo G0244.15
1xLED SMD 15W 4500K	Oro G0244.16





G0244.05

GOCCIA

Design Ufficio Tecnico

LED
SMD



Lampada a luce diffusa. Struttura in metallo verniciato. Reggivetrol cromati/ottinati, vetro satinato bianco. Disponibile anche con illuminazione a LED SMD multi-chip a luce bianca naturale.

Lamps giving diffused light. Painted metal frame, chromed / brassed glassholders, white satin glass diffuser. Also available with multi-chip SMD LED natural white light.

Lampen mit diffusem Licht. Struktur aus lackiertem Metall, Glashalter verchromt oder vermessingt, Glas Diffusor weiß satiniert. Die Leuchte ist auch mit LED SMD multi-chip erhältlich, weiß Tageslicht.

Lampes à lumière diffuse. Structure en métal vernisé. Supports du verre chromé ou laiton, diffuseur en verre satiné blanc. Le produit est aussi disponible dans la version avec LED SMD multi-chip, lumière blanche naturelle.

Luminaria de luz difusa. Estructura de metal pintado. Fijador de cristal cromado/latonado, cristal satinado. Disponible tambien con LED SMD multi-chip a luz blanca natural.





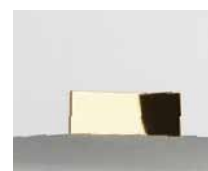

Cromo

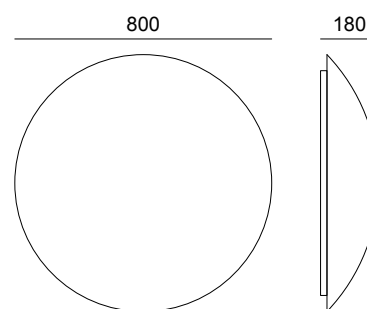
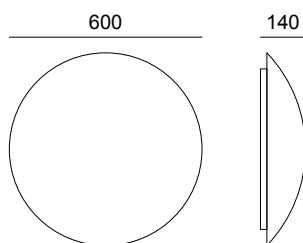
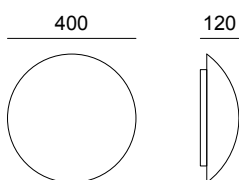





Ottone







elettrificazione	finitura	codice
2xE27 42W  	Cromo	G0243.01
2xE27 42W  	Ottone	G0243.02
1xLED SMD 15W 4500K	Cromo	G0243.21
1xLED SMD 15W 4500K	Ottone	G0243.22

IP 20   

elettrificazione	finitura	codice
4xE27 42W 	Cromo	G0243.03
4xE27 42W 	Ottone	G0243.04
4x2G11 18W 	Cromo	G0243.05
4x2G11 18W 	Ottone	G0243.06
1xLED SMD 19W 4500K	Cromo	G0243.23
1xLED SMD 19W 4500K	Ottone	G0243.24

IP 20   

elettrificazione	finitura	codice
6xE27 42W 	Cromo	G0243.09
6xE27 42W 	Ottone	G0243.10
4x2G11 24W 	Cromo	G0243.11
4x2G11 24W 	Ottone	G0243.12
4xLED SMD 9W 4500K	Cromo	G0243.29
4xLED SMD 9W 4500K	Ottone	G0243.30

IP 20   

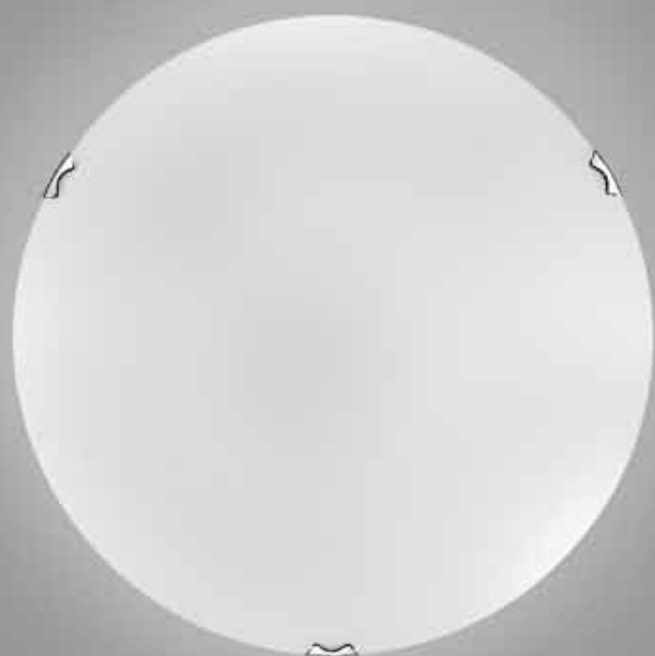

LOOP

Design Ufficio Tecnico

LED
SMD



Lampada a luce diffusa. Struttura in metallo verniciato. Finali in vetro di Murano, diffusore in vetro satinato bianco. Disponibile anche con illuminazione a LED SMD multi-chip a luce bianca naturale.

Lamps giving diffused light. Painted metal frame, Murano glass parts, white satin glass diffuser. Also available with multi-chip SMD LED natural white light.

Lampen mit diffusem Licht. Struktur aus lackiertem Metall, Murano Glas-Teile, Glas Diffusor weiss satiniert. Die Leuchte ist auch mit LED SMD multi-chip erhältlich, weiß Tageslicht.

Lampes à lumière diffuse. Structure en métal vernisé. Détails en verre de Murano, diffuseur en verre satiné blanc. Le produit est aussi disponible dans la version avec LED SMD multi-chip, lumière blanche naturelle.

Luminaria de luz difusa. Estructura de metal pintado. Finales de cristal de Murano, difusor de cristal. Disponible tambien con LED SMD multi-chip a luz blanca natural.



Trasparente



Ambra

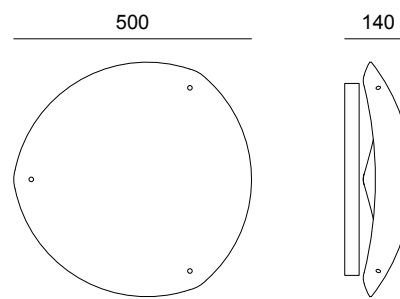
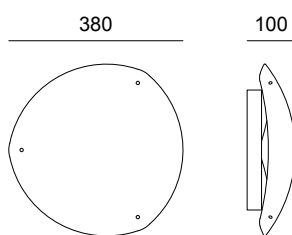
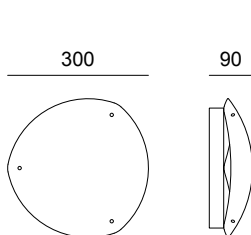

elettrificazione	colore	codice
1xE14 42W	Trasparente	G0260.01
1xE14 42W	Ambra	G0260.04



elettrificazione	colore	codice
1xE27 42W	Trasparente	G0260.07
1xE27 42W	Ambra	G0260.10
1xLED SMD 9W 4500K	Trasparente	G0260.37
1xLED SMD 9W 4500K	Ambra	G0260.40



elettrificazione	colore	codice
2xE27 42W	Trasparente	G0260.13
2xE27 42W	Ambra	G0260.16
1xLED SMD 19W 4500K	Trasparente	G0260.43
1xLED SMD 19W 4500K	Ambra	G0260.46





SOLE

Design Ufficio Tecnico

LED
SMD



Lampade a luce diffusa. Struttura in metallo verniciato, diffusore in vetro satinato. Reggivetrol in pressofusione. Disponibile anche con illuminazione a LED SMD multi-chip a luce bianca naturale.

Lamp giving diffused light. Painted metal frame, satin glass diffuser, die-cast glassholders. Also available with multi-chip SMD LED natural white light.

Lampe mit diffusem Licht. Struktur aus lackiertem Metall, Glas Diffusor satiniert. Glashalter aus Druckguß. Die Leuchte ist auch mit LED SMD multi-chip erhältlich, weiß Tageslicht.

Lampe à lumière diffuse. Structure en métal vernisé. Diffuseur en verre satiné, Support du verre en laiton moulé. Le produit est aussi disponible dans la version avec LED SMD multi-chip, lumière blanche naturelle.

Luminaria de luz difusa. Estructura de metal pintado, difusor de cristal satinado. Fijador del cristal de fundición. Disponible tambien con LED SMD multi-chip a luz blanca natural.

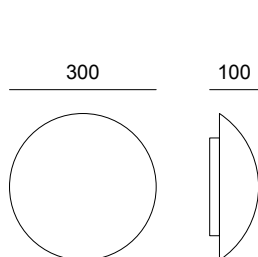

elettrificazione	finitura	codice
1xE27 42W	Cromo	G0210.03
1xLED SMD 9W 4500K	Cromo	G0210.13

IP 20 CE

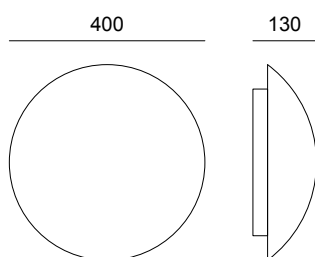

elettrificazione	finitura	codice
2xE27 42W	Cromo	G0210.05
1xLED SMD 15W 4500K	Cromo	G0210.15

IP 20 CE



PLANET

Design Ufficio Tecnico

LED
SMD



Lampada a luce diffusa. Struttura in metallo verniciato. Finali in vetro di Murano, diffusore in vetro satinato bianco. Disponibile anche con illuminazione a LED SMD multi-chip a luce bianca naturale.

Lamps giving diffused light. Painted metal frame, Murano glass parts, white satin glass diffuser. Also available with multi-chip SMD LED natural white light.

Lampen mit diffusem Licht. Struktur aus lackiertem Metall, Murano Glas-Teile, Glas Diffusor weiß satiniert. Die Leuchte ist auch mit LED SMD multi-chip erhältlich, weiß Tageslicht.

Lampes à lumière diffuse. Structure en métal vernisé. Détails en verre de Murano, diffuseur en verre satiné blanc. Le produit est aussi disponible dans la version avec LED SMD multi-chip, lumière blanche naturelle.

Luminaria de luz difusa. Estructura de metal pintado. Finales de cristal de Murano, difusor de cristal satinado blanco. Disponible tambien con LED SMD multi-chip a luz blanca natural.



Trasparente



Ambra

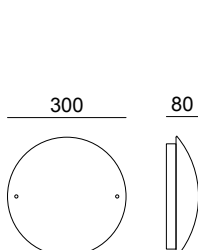

elettrificazione	colore	codice
1xE14 42W	Trasparente	G0262.03
1xE14 42W	Ambra	G0262.05
1xLED SMD 9W 4500K	Trasparente	G0262.43
1xLED SMD 9W 4500K	Ambra	G0262.45

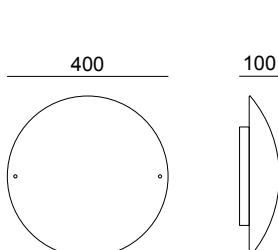

elettrificazione	colore	codice
2xE27 42W	Trasparente	G0262.09
2xE27 42W	Ambra	G0262.12
1xLED SMD 15W 4500K	Trasparente	G0262.49
1xLED SMD 15W 4500K	Ambra	G0262.52

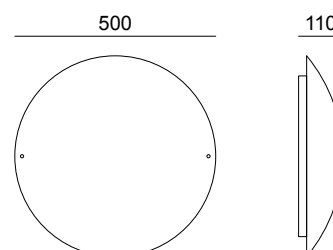

elettrificazione	colore	codice
2xE27 52W	Trasparente	G0262.20
2xE27 52W	Ambra	G0262.23
1xLED SMD 19W 4500K	Trasparente	G0262.60
1xLED SMD 19W 4500K	Ambra	G0262.63





LUNA

Design Ufficio Tecnico

LED
SMD



Lampade a luce diffusa. Struttura in metallo verniciato. Diffusore e anello in vetro satinato. Disponibile anche con illuminazione a LED SMD multi-chip a luce bianca naturale.

Lamps giving diffused light. Painted metal frame, satin glass diffuser and glass ring. Also available with multi-chip SMD LED natural white light.

Lampen mit diffusem Licht. Struktur aus lackiertem Metall, Diffusor und Ring aus Glas satiniert. Die Leuchte ist auch mit LED SMD multi-chip erhältlich, weiß Tageslicht.

Lampes à lumière diffuse. Structure en métal vernisé. Diffuseur et anneau en verre satiné blanc. Le produit est aussi disponible dans la version avec LED SMD multi-chip, lumière blanche naturelle.

Luminaria de luz difusa. Estructura de metal pintado. Difusor y cornisa de cristal satinado. Disponible tambien con LED SMD multi-chip a luz blanca natural.



Satinato



Ambra

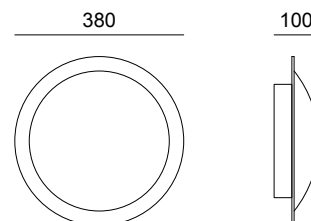
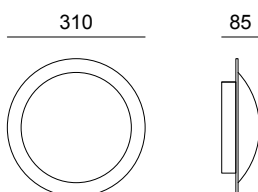
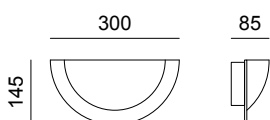

elettrificazione	colore	codice
1xE27 42W	Satinato	G0247.01
1xE27 42W	Ambra	G0247.05
1xLED SMD 2.9W 4500K	Satinato	G0247.21
1xLED SMD 2.9W 4500K	Ambra	G0247.25

IP 20 CE

elettrificazione	colore	codice
1xE27 42W	Satinato	G0247.06
1xE27 42W	Ambra	G0247.10
1xLED SMD 9W 4500K	Satinato	G0247.26
1xLED SMD 9W 4500K	Ambra	G0247.30

IP 20 CE

elettrificazione	colore	codice
2xE27 42W	Satinato	G0247.11
2xE27 42W	Ambra	G0247.15
1xLED SMD 15W 4500K	Satinato	G0247.31
1xLED SMD 15W 4500K	Ambra	G0247.35

IP 20 CE



LENTE

Design Ufficio Tecnico

LED
SMD



Lampada a luce diffusa. Struttura in metallo verniciato e reggivetri cromati/ottoneati. Il vetro è disponibile nella finitura satinato bianco, con decoro damascato o spezzettato. Disponibile anche con illuminazione a LED SMD multi-chip.

Wall and ceiling lamps giving diffuse lighting. Painted metal frame and glassholders available in chrome or gold finish. White satin glass diffuser, also available with damask or with stick designs. Also available with multichip SMD LEDs.

Wand- und Deckenleuchten für diffuse Lichtverteilung. Metallarmatur lackiert und Glashalterfedern verchromt oder vermessingt, Glas Diffusor erhältlich weiß satiniert, mit Damast- oder Streifendekor. Die Leuchte ist auch mit LED SMD multichip erhältlich.

Collection d'appliques et plafonniers à lumière diffuse. Structure en métal vernisé, support du verre chromé ou laitoné, diffuseur en verre satiné blanc, disponible aussi avec un design damassé ou aux lignes cassées. Le produit peut être aussi équipé avec LED SMD multi-chip.

Serie de luminaria de pared y de techo de luz difusa. Estructura de metal pintado, difusor disponible en cristal satinado, con decoración damascado y con líneas quebradas. Disponible también con LED SMD multi-chip.



Bianco

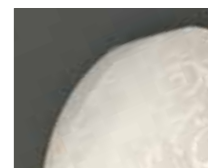

Damascato



Spezzato

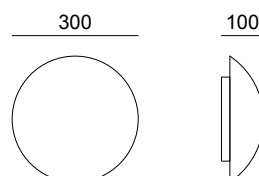
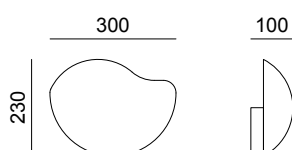

elettrificazione	finitura	codice
1xE27 52W	Cromo/Bianco	G0258.01
1xE27 52W	Ottone/Bianco	G0258.02
LED SMD 4.4W 4500K	Cromo/Bianco	G0258.21
LED SMD 4.4W 4500K	Ottone/Bianco	G0258.22
1xE27 52W	Cromo/Damascato	G0258.31
1xE27 52W	Ottone/Damascato	G0258.32
LED SMD 4.4W 4500K	Cromo/Damascato	G0258.41
LED SMD 4.4W 4500K	Ottone/Damascato	G0258.42
1xE27 52W	Cromo/Spezzato	G0258.51
1xE27 52W	Ottone/Spezzato	G0258.52
LED SMD 4.4W 4500K	Cromo/Spezzato	G0258.61
LED SMD 4.4W 4500K	Ottone/Spezzato	G0258.62

IP 20 V E CE

elettrificazione	finitura	codice
1xE27 52W	Cromo/Bianco	G0258.03
1xE27 52W	Ottone/Bianco	G0258.04
1xLED SMD 9W 4500K	Cromo/Bianco	G0258.23
1xLED SMD 9W 4500K	Ottone/Bianco	G0258.24
1xE27 52W	Cromo/Damascato	G0258.33
1xE27 52W	Ottone/Damascato	G0258.34
1xLED SMD 9W 4500K	Cromo/Damascato	G0258.43
1xLED SMD 9W 4500K	Ottone/Damascato	G0258.44
1xE27 52W	Cromo/Spezzato	G0258.53
1xE27 52W	Ottone/Spezzato	G0258.54
1xLED SMD 9W 4500K	Cromo/Spezzato	G0258.63
1xLED SMD 9W 4500K	Ottone/Spezzato	G0258.64

IP 20 V E CE

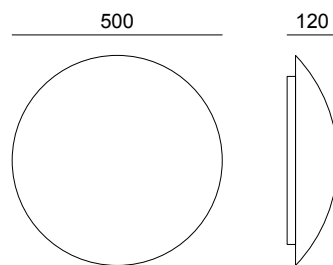
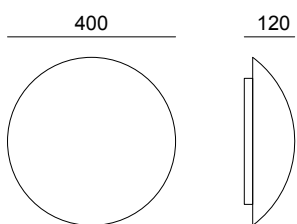

elettrificazione	finitura	codice
2xE27 42W	Cromo/Bianco	G0258.05
2xE27 42W	Ottone/Bianco	G0258.06
2xGX24q3 26W	Cromo/Bianco	G0258.07
1xLED SMD 15W 4500K	Cromo/Bianco	G0258.25
1xLED SMD 15W 4500K	Ottone/Bianco	G0258.26
2xE27 42W	Cromo/Damascato	G0258.35
2xE27 42W	Ottone/Damascato	G0258.36
1xLED SMD 15W 4500K	Cromo/Damascato	G0258.45
1xLED SMD 15W 4500K	Ottone/Damascato	G0258.46
2xE27 42W	Cromo/Spezzato	G0258.55
2xE27 42W	Ottone/Spezzato	G0258.56
1xLED SMD 15W 4500K	Cromo/Spezzato	G0258.65
1xLED SMD 15W 4500K	Ottone/Spezzato	G0258.66

IP 20 V E CE

elettrificazione	finitura	codice
3xE27 52W	Cromo/Bianco	G0258.08
3xE27 52W	Ottone/Bianco	G0258.09
1xLED SMD 19W 4500K	Cromo/Bianco	G0258.28
1xLED SMD 19W 4500K	Ottone/Bianco	G0258.29
3xE27 52W	Cromo/Damascato	G0258.38
3xE27 52W	Ottone/Damascato	G0258.39
1xLED SMD 19W 4500K	Cromo/Damascato	G0258.48
1xLED SMD 19W 4500K	Ottone/Damascato	G0258.49
3xE27 52W	Cromo/Spezzato	G0258.58
3xE27 52W	Ottone/Spezzato	G0258.59
1xLED SMD 19W 4500K	Cromo/Spezzato	G0258.68
1xLED SMD 19W 4500K	Ottone/Spezzato	G0258.69

IP 20 V E CE

Emergency



G0258.05



G2058.03



LED
SMD



BRACCIALE

Design Ufficio Tecnico

Lampada da parete a luce diffusa. Struttura in metallo verniciato bianco. Diffusore in vetro satinato. Disponibile anche con illuminazione a LED SMD multi-chip a luce bianca naturale.

Wall lamp giving diffuse light. White painted metal frame. Satin glass diffuser. Also available with multi-chip SMD LED natural white light.

Wandleuchte mit diffusem licht. Metallstruktur weiß lackiert. Glasdiffusor satiniert. Die Leuchte ist auch mit LED SMD multi-chip erhältlich, weiß Tageslicht.

Applique à lumière diffuse. Structure en métal vernisé blanc. Diffuseur en verre satiné. Le produit est aussi disponible dans la version avec LED SMD multi-chip, lumière blanche naturelle.

Luminaria de luz difusa. Estructura de metal pintado blanco. Difusor de cristal satinado. Disponible tambien con LED SMD multi-chip a luz blanca natural.

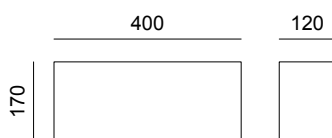
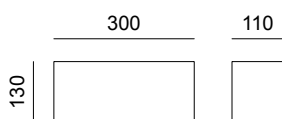

elettrificazione	colore	codice
1xR7s 80W 78mm	Bianco	G0161.02
LED SMD 5.5W 4500K	Bianco	G0161.32



elettrificazione	colore	codice
1xR7s 120W 118mm	Bianco	G0161.05
LED SMD 15.4W 4500K	Bianco	G0161.35





PLATE

Design Ufficio Tecnico

LED
SMD



Montatura in metallo. Diffusori in vetro in piastra trasparente e colorato. Particolari in cromo. Disponibile anche con illuminazione a LED SMD multi-chip a luce bianca naturale.

Metal frame. Artistic glass diffuser transparent and coloured. Chrome details. Also available with multi-chip SMD LED natural white light.

Metallarmatur. Diffusor aus Kunstglas, transparent und farbig. Verchromte Teile. Die Leuchte ist auch mit LED SMD multi-chip erhältlich, weiß Tageslicht.

Structure en métal. Diffuseur en verre artistique transparent et en couleurs. Détails chromés. Le produit est aussi disponible dans la version avec LED SMD multi-chip, lumière blanche naturelle.

Estructura de metal. Difusor en vidrio artistico transparente y colorado. Particulares en cromo. Disponible tambien con LED SMD multi-chip a luz blanca natural.



G3117.03



Cristallo



Ambra

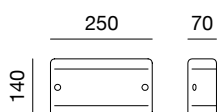

elettrificazione	colore	codice
1xR7s 80W 78mm	Cristallo	G3117.01
1xR7s 80W 78mm	Ambra	G3118.01
1xLED SMD 2.9W 4500K	Cristallo	G3117.11
1xLED SMD 2.9W 4500K	Ambra	G3118.11

IP 20

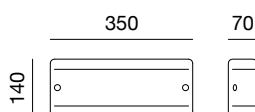

elettrificazione	colore	codice
1xG24q2 18W	Cristallo	G3117.02
1xG24q2 18W	Ambra	G3118.02
1xR7s 120W 118mm	Cristallo	G3117.03
1xR7s 120W 118mm	Ambra	G3118.03
2xLED SMD 2.9W 4500K	Cristallo	G3117.12
2xLED SMD 2.9W 4500K	Ambra	G3118.12

IP 20

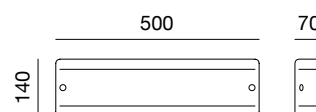

elettrificazione	colore	codice
1xG24q3 26W	Cristallo	G3117.04
1xG24q3 26W	Ambra	G3118.04
LED SMD 7.7W 4500K	Cristallo	G3117.14
LED SMD 7.7W 4500K	Ambra	G3118.14

IP 20





PIEGA

Design Ufficio Tecnico

LED
SMD



Lampada a luce diffusa. Struttura in metallo verniciato, diffusore in vetro verniciato. Disponibile anche con illuminazione a LED SMD multi-chip a luce bianca naturale.

Lamp giving diffused light. Painted metal frame, painted glass diffuser. Also available with multi-chip SMD LED natural white light.

Lampe mit diffusem Licht. Struktur aus lackiertem Metall, lackierter Glas Diffusor. Die Leuchte ist auch mit LED SMD multi-chip erhältlich, weiß Tageslicht.

Lampe à lumière diffuse. Structure en métal vernisé, diffuseur en verre vernisé. Le produit est aussi disponible dans la version avec LED SMD multi-chip, lumière blanche naturelle.

Luminaria de luz difusa. Estructura de metal pintado, difusor de cristal pintado. Disponible tambien con LED SMD multi-chip a luz blanca natural.

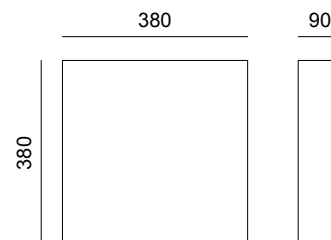
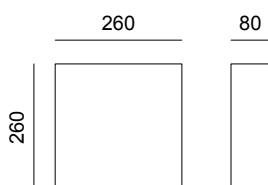
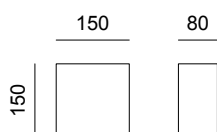
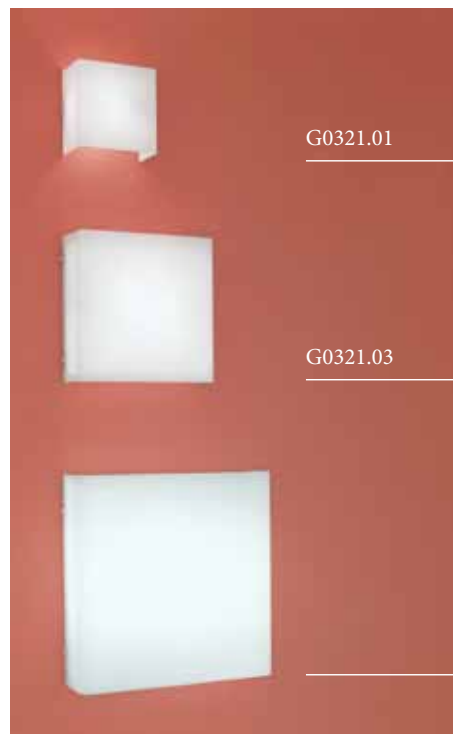

elettrificazione	colore	codice
1xG9 48W	Bianco	G0321.01
1x LED SMD 2.9W 4500K	Bianco	G0321.11

elettrificazione	colore	codice
2xG24q2 18W	Bianco	G0321.03
2xG9 48W	Bianco	G0321.04
1x LED SMD 9W 4500K	Bianco	G0321.13

elettrificazione	colore	codice
4x2G11 18W	Bianco	G0321.05
2xE27 42W	Bianco	G0321.06
LED SMD 30.8W 4500K	Bianco	G0321.15



TESSY

Design Ufficio Tecnico

LED
SMD



Lampada a luce diffusa. Struttura in nichel spazzolato. Diffusore in vetro satinato bianco. Disponibile anche con illuminazione a LED SMD multi-chip a luce bianca naturale.

Lamp giving diffused light. Brushed nickel metal frame, white satin glass diffuser. Also available with multi-chip SMD LED natural white light.

Lampe mit diffusem Licht. Struktur aus nickel gebürstetem Metall, Glas Diffusor weiß satiniert. Die Leuchte ist auch mit LED SMD multi-chip erhältlich, weiß Tageslicht.

Lampe à lumière diffuse. Structure en nickel brossé. Diffuseur en verre blanc satiné. Le produit est aussi disponible dans la version avec LED SMD multi-chip, lumière blanche naturelle.

Luminaria de luz difusa. Estructura de níquel bruñido. Difusor de cristal satinado blanco. Disponible también con LED SMD multi-chip a luz blanca natural.

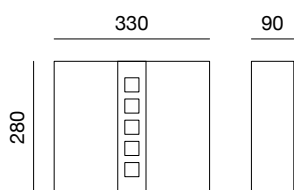

elettrificazione	colore	codice
1xE27 52W	Satinato	G3101.02
1xLED SMD 9W 4500K	Satinato	G3101.03

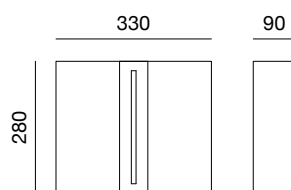

elettrificazione	colore	codice
1xE27 52W	Satinato	G3103.02
1xLED SMD 9W 4500K	Satinato	G3103.03

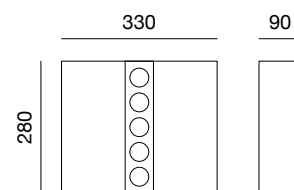

elettrificazione	colore	codice
1xE27 52W	Satinato	G3100.02
1xLED SMD 9W 4500K	Satinato	G3100.03





HOTEL

Design Ufficio Tecnico

LED
SMD



Lampada a luce diffusa. Struttura in metallo verniciato. Diffusore in vetro serigrafato bianco o silver, reggivetro cromati. Disponibile anche con illuminazione a LED SMD multi-chip a luce bianca naturale.

Lamp giving diffused light. Painted metal frame. Silk-screen printed glass diffuser available in white or in silver. Also available with multi-chip SMD LED natural white light.

Lampe mit diffusem Licht. Struktur aus lackiertem Metall. Glas Diffusor siebgedruckt weiß oder silber, Glashalter verchromt. Die Leuchte ist auch mit LED SMD multi-chip erhältlich, weiß Tageslicht.

Lampe à lumière diffuse. Structure en métal vernisé. Diffuseur en verre sérigraphié blanc ou argent. Support du verre chromé. Le produit est aussi disponible dans la version avec LED SMD multi-chip, lumière blanche naturelle.

Luminaria de luz difusa. Estructura de metal pintado. Difusor de cristal serigrafado blanco o plata, fijador cristal cromado. Disponible tambien con LED SMD multi-chip a luz blanca natural.



Bianco



Silver

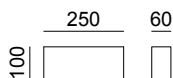

elettrificazione	colore	codice
1xR7s 80W 78mm	Bianco	G3115.01
1xR7s 80W 78mm	Silver	G3116.01
1xLED SMD 2.9W 4500K	Bianco	G3115.11
1xLED SMD 2.9W 4500K	Silver	G3116.11

IP 20 V ⊕ CE

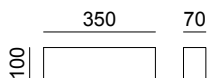

elettrificazione	colore	codice
1xG24q2 18W	Bianco	G3115.02
1xG24q2 18W	Silver	G3116.02
1xR7s 120W 118mm	Bianco	G3115.03
1xR7s 120W 118mm	Silver	G3116.03
2xLED SMD 2.9W 4500K	Bianco	G3115.12
2xLED SMD 2.9W 4500K	Silver	G3116.12

IP 20 V ⊕ CE

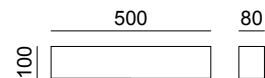

elettrificazione	colore	codice
1xG24q3 26W	Bianco	G3115.04
1xG24q3 26W	Silver	G3116.04
LED SMD 7.7W 4500K	Bianco	G3115.14
LED SMD 7.7W 4500K	Silver	G3116.14

IP 20 V ⊕ CE

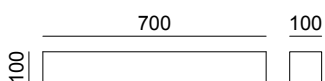

elettrificazione	colore	codice
1x2G11 36W	Bianco	G3115.05
1x2G11 36W	Silver	G3116.05
LED SMD 15.4W 4500K	Bianco	G3115.15
LED SMD 15.4W 4500K	Silver	G3116.15

IP 20 V ⊕ CE

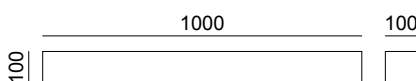

elettrificazione	colore	codice
1x2G11 55W	Bianco	G3115.06
1x2G11 55W	Silver	G3116.06
LED SMD 15.4W 4500K	Bianco	G3115.16
LED SMD 15.4W 4500K	Silver	G3116.16

IP 20 V ⊕ CE



G3115.06

G3115.02

G3116.01



G3116.02
G3116.03



G3116.04



G3116.05



G3116.06



G3115.02



G3116.04

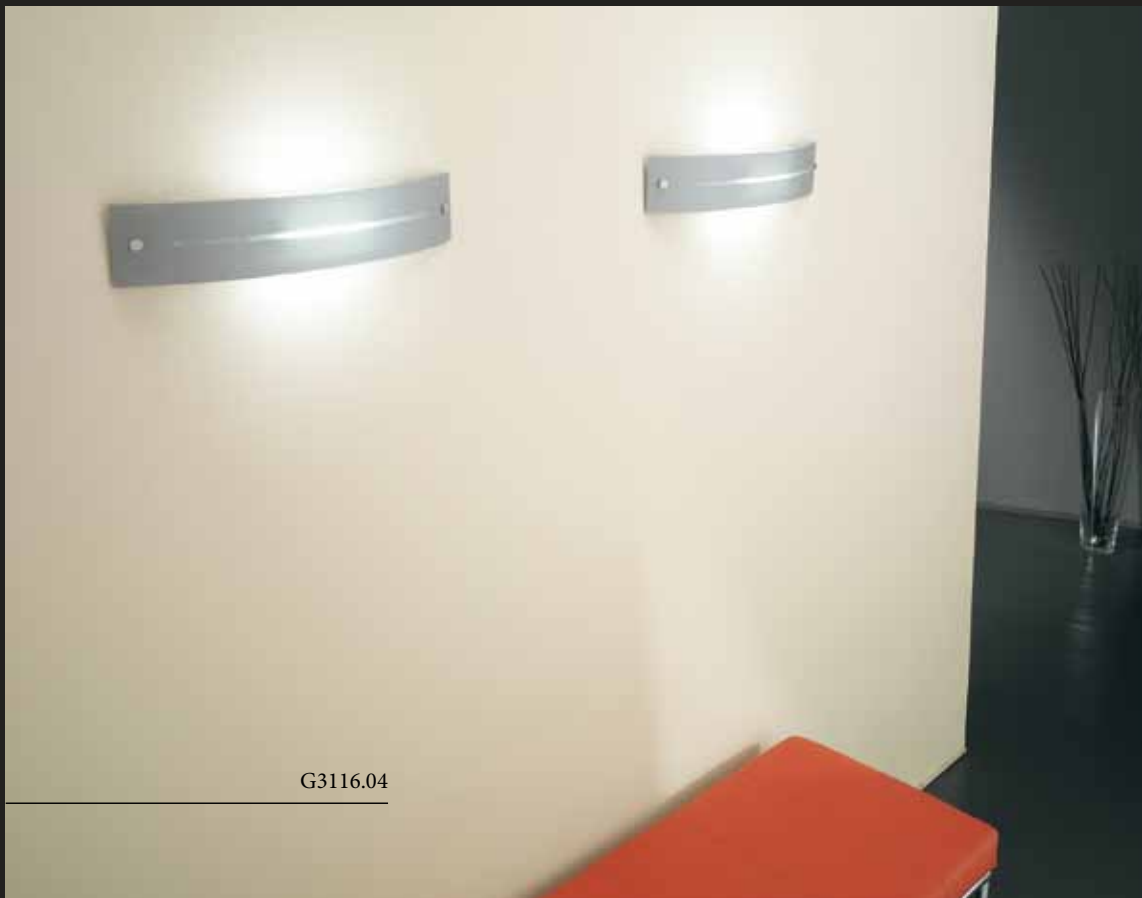

SPRINT

Design Ufficio Tecnico

Lampada a luce diffusa. Struttura in metallo cromato. Diffusore in vetro opale satinato.





Lamps giving diffused light. Chromed metal frame, opal satin glass diffuser.

Lampen mit diffusem Licht. Struktur aus verchromtem Metall, Diffusor aus Opalsatiniertem Glas.

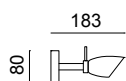



Lampes à lumière diffuse. Structure en métal chromé. Diffuseur en verre opale satiné.

Luminaria de luz difusa. Estructura de metal cromado. Difusor de cristal opal satinado.

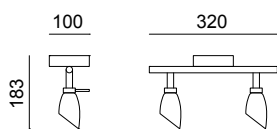





elettrificazione	finitura	codice
1xG9 20W 	Cromo	G2052.01
   		

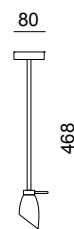

elettrificazione	finitura	codice
2xG9 20W 	Cromo	G2052.02
   		



elettrificazione	finitura	codice
1xG9 20W 	Cromo	G2052.07
   		





G2052.02



SMART

Design Ufficio Tecnico

Lampada a luce diffusa. Struttura in metallo cromato. Diffusore in vetro opale satinato.





Lamps giving diffused light. Chromed metal frame, opal satin glass diffuser.

Lampen mit diffusem Licht. Struktur aus verchromtem Metall, Diffusor aus Opalsatiniertem Glas.

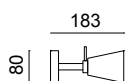



Lampes à lumière diffuse. Structure en métal chromé. Diffuseur en verre opale satiné.

Luminaria de luz difusa. Estructura de metal cromado. Difusor de cristal opal satinado.

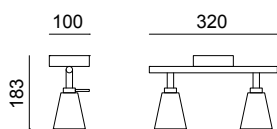





elettrificazione	finitura	codice
1xG9 20W 	Cromo	G2051.01
	   	

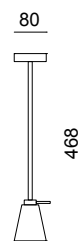

elettrificazione	finitura	codice
2xG9 20W 	Cromo	G2051.02
	   	



elettrificazione	finitura	codice
1xG9 20W 	Cromo	G2051.07
	   	





G2051.02



ACUTA

Design Ufficio Tecnico

Serie di lampade a luce diffusa da parete, da soffitto o da tavolo. Diffusore in vetro opale satinato. Struttura in metallo nickel spazzolato.

Range of wall, ceiling, pendant and table luminaires with diffuse light. Opal satin glass diffuser. Metal nickel brushed frame.

Kollektion von Wand-, Decken-, Pendel- und Tischleuchten mit diffusem Licht. Diffusor aus Opalsatiniertem Glas. Struktur Nickel gebürstet.

Collection d'appliques, plafonniers, suspensions et lampes à poser. Diffuseur en verre opale satiné. Structure en métal nickel brossé.

Serie de luminarias de luz difusa de pared, de techo o de pié. Difusor de cristal opal satinado. La estructura metálica es en níquel bruñido.

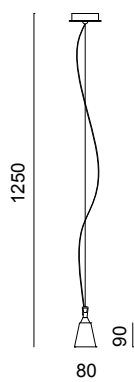

elettrificazione	colore	codice
1xG9 48W	Bianco	M124.03

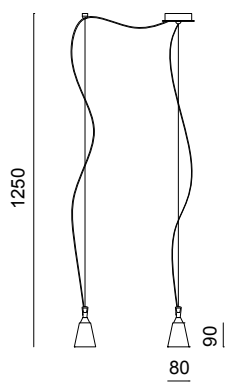

elettrificazione	colore	codice
2xG9 48W	Bianco	M124.04

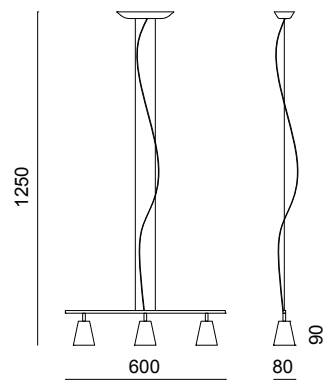

elettrificazione	colore	codice
3xG9 48W	Bianco	M124.05



elettrificazione	colore	codice
1xG9 48W	Bianco	M124.01



elettrificazione	colore	codice
1xG9 48W	Bianco	M124.06

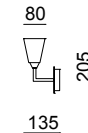

elettrificazione	colore	codice
1xG9 48W	Bianco	M124.08





M124.01



M124.08

M124.04



M124.06



UFO

Design Ufficio Tecnico

Lampade in metallo con finitura nichel spazzolato. Fascio luminoso orientabile.

Metal luminaires with flexible arms available in brushed nickel.

Metalleuchten mit flex Arm erhältlich in nickel gebürstet.

Collection de lampes en métal avec tiges flexibles, disponibles en nickel brossé.

Luminaria de metal con acabado níquel bruñido. Haz luminoso orientable.

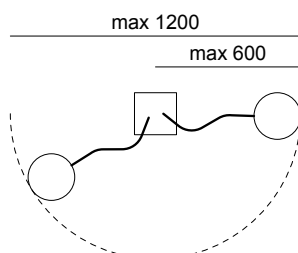
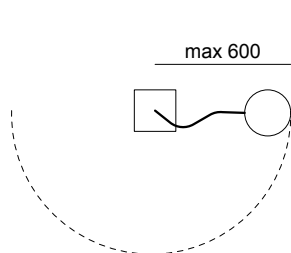

elettrificazione	finitura	codice
1xG53 R111 50W	Nichel Spazzolato	G2045.01
trasformatore incluso/transformer included		
lampadina inclusa/bulb included	IP 20	VF

elettrificazione	finitura	codice
2xG53 R111 50W	Nichel Spazzolato	G2045.02
trasformatore incluso/transformer included		
lampadina inclusa/bulb included	IP 20	VF

G2045.02



G2045.01

PRETTY

Design Ufficio Tecnico

LED
SMD



Lampada a luce diffusa. Struttura in metallo verniciato. Diffusore in vetro satinato bianco. Disponibile anche con illuminazione a LED SMD multi-chip a luce bianca naturale.

Lamps giving diffused light. Painted metal frame, white satin glass diffuser. Also available with multi-chip SMD LED natural white light.

Lampen mit diffusem Licht. Struktur aus lackiertem Metall, Glas-Diffusor weiß satiniert. Die Leuchte ist auch mit LED SMD multi-chip erhältlich, weiß Tageslicht.

Lampes à lumière diffuse. Structure en métal vernisé. Diffuseur en verre satiné blanc. Le produit est aussi disponible dans la version avec LED SMD multi-chip, lumière blanche naturelle.

Luminaria de luz difusa. Estructura de metal pintado. Finales de cristal de Murano, difusor de cristal. Disponible tambien con LED SMD multi-chip a luz blanca natural.

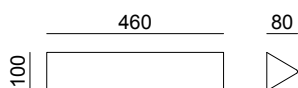

elettrificazione		colore	codice
1x2G11 24W		Bianco	G0276.02
LED SMD 7.7W 4500K		Bianco	G0276.06





ASSO

Design Ufficio Tecnico

LED
SMD



Lampada a luce diffusa. Struttura in metallo verniciato, diffusore in vetro satinato bianco o ambra. Disponibile anche con illuminazione a LED SMD multi-chip a luce bianca naturale.

Lamp giving diffused light. Painted metal frame. White or amber satin glass diffuser. Also available with multi-chip SMD LED natural white light.

Lampe mit diffusem Licht. Glas Diffusor weiß satiniert oder ambra. Die Leuchte ist auch mit LED SMD multi-chip erhältlich, weiß Tageslicht.

Lampe à lumière diffuse. Structure en métal vernisé blanc. Diffuseur en verre blanc satiné ou ambra. Le produit est aussi disponible dans la version avec LED SMD multi-chip, lumière blanche naturelle.

Luminaria de luz difusa. Estructura de metal pintado, difusor de cristal satinado blanco ó ambra. Disponible también con LED SMD multi-chip a luz blanca natural.



Ambra



Bianco

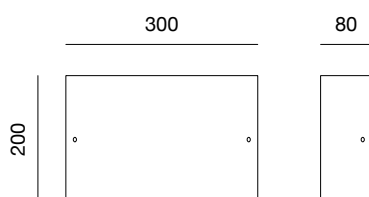

elettrificazione		colore	codice
2xG24d2 18W		Bianco	G3105.01
1xG24q2 18W		Bianco	G3105.02
1xR7s 120W 118mm		Bianco	G3105.03
LED SMD 7.7W 4500K		Bianco	G3105.07
2xG24d2 18W		Ambra	G3105.04
1xG24q2 18W		Ambra	G3105.05
1xR7s 120W 118mm		Ambra	G3105.06
LED SMD 7.7W 4500K		Ambra	G3105.08

IP 20



DAMA 1

Design Ufficio Tecnico

Lampada a luce diffusa. Struttura in metallo verniciato. Diffusore in vetro satinato con decori colorati lavorati a muffola. Disponibile anche con illuminazione a LED SMD multi-chip a luce bianca naturale.

Lamp giving diffused light. Painted metal frame. Satin glass diffuse with coloured muffled details. Also available with multi-chip SMD LED natural white light.

Lampe mit diffusem Licht. Struktur aus lackiertem Metall. Glas Diffusor satiniert mit farbigen Muffel Details. Die Leuchte ist auch mit LED SMD multi-chip erhältlich, weiß Tageslicht.

Lampe à lumière diffuse. Structure en métal vernisé. Diffuseur en verre satiné avec détails en couleurs travaillés à moufle. Le produit est aussi disponible dans la version avec LED SMD multi-chip, lumière blanche naturelle.

Luminaria de luz difusa. Estructura de metal pintado. Difusor de cristal satinado enmohecido. Disponible tambien con LED SMD multi-chip a luz blanca natural.

LED
SMD



Ambra

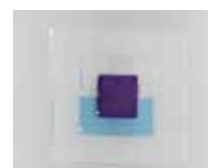

Blu

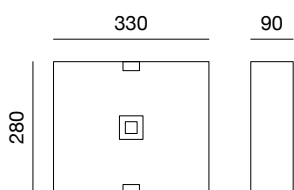

elettrificazione		colore	codice
1xE27 52W		Ambra	G3107.01
1xR7s 80W 78mm		Ambra	G3107.02
2xG24d2 18W		Ambra	G3107.03
1xLED SMD 9W 4500K		Ambra	G3107.11
1xE27 52W		Blu	G3107.04
1xR7s 80W 78mm		Blu	G3107.05
2xG24d2 18W		Blu	G3107.06
1xLED SMD 9W 4500K		Blu	G3107.14

IP 20



DAMA 2

Design Ufficio Tecnico

LED
SMD



Lampada a luce diffusa. Struttura in metallo verniciato. Diffusore in vetro satinato. Disponibile anche con illuminazione a LED SMD multi-chip a luce bianca naturale.

Lamp giving diffused light. Painted metal frame, painted glass diffuser. Also available with multi-chip SMD LED natural white light.

Lampe mit diffusem Licht. Struktur aus lackiertem Metall, lackierter Glas Diffusor. Die Leuchte ist auch mit LED SMD multi-chip erhältlich, weiß Tageslicht.

Lampe à lumière diffuse. Structure en métal vernisé, diffuseur en verre vernisé. Le produit est aussi disponible dans la version avec LED SMD multi-chip, lumière blanche naturelle.

Luminaria de luz difusa. Estructura de metal pintado. Difusor de cristal satinado. Disponible tambien con LED SMD multi-chip a luz blanca natural.



Ambra



Bianco

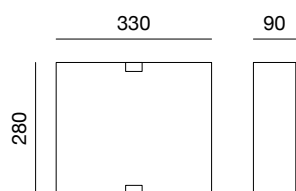

elettrificazione		colore/finitura	codice
1xE27 52W		Bianco/Cromo	G3111.01
1xR7s 80W 78mm		Bianco/Cromo	G3111.02
2xG24d2 18W		Bianco/Cromo	G3111.03
1xLED SMD 9W 4500K		Bianco/Cromo	G3111.11
1xE27 52W		Ambra/Oro	G3111.04
1xR7s 80W 78mm		Ambra/Oro	G3111.05
2xG24d2 18W		Ambra/Oro	G3111.06
1xLED SMD 9W 4500K		Ambra/Oro	G3111.14

IP 20



G3111.01

COPPINO

Design Ufficio Tecnico

LED
SMD



Lampade a luce diffusa. Diffusore in vetro bianco satinato o ambra, particolare in metallo cromato o ottonato. Disponibile anche con illuminazione a LED SMD multi-chip a luce bianca naturale.

Lamp giving diffused light. White or amber satin glass diffuser, chromed or brassed metal details. Also available with multi-chip SMD LED natural white light.

Lampe mit diffusem Licht. Glas Diffusor weiß satiniert oder amber, Metall Details verchromt oder vermessingt. Die Leuchte ist auch mit LED SMD multi-chip erhältlich, weiß Tageslicht.

Lampe à lumière diffuse. Diffuseur en verre blanc satiné ou ambre, détails en métal chromé ou laiton. Le produit est aussi disponible dans la version avec LED SMD multi-chip, lumière blanche naturelle.

Luminaria de luz difusa. Estructura de cristal satinado blanco o ambar, complementos de metal cromado ó latonado. Disponible tambien con LED SMD multi-chip a luz blanca natural.

Modelli depositati / Patent pending





Ambra

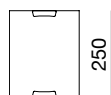

Bianco



elettrificazione	colore	codice
2xE14 28W 	Bianco	M110.3
1xLED SMD 9W 4500K	Bianco	M110.8
2xE14 28W 	Ambra	M110.6
1xLED SMD 9W 4500K	Ambra	M110.9

IP 20   



BAUTA

Design Federico Codato

LED
SMD



Lampade a luce diffusa. Diffusore in vetro bianco satinato o ambra, particolare in metallo cromato. Disponibile anche con illuminazione a LED SMD multi-chip a luce bianca naturale.

Lamp giving diffused light. White or amber satin glass diffuser, metal details available in chrome. Also available with multi-chip SMD LED natural white light.

Lampe mit diffusem Licht. Glas Diffusor weiß satiniert oder ambra, Metallhalterungen in chrom. Die Leuchte ist auch mit LED SMD multi-chip erhältlich, weiß Tageslicht.

Lampe à lumière diffuse. Diffuseur en verre blanc satiné ou ambre, détails en métal chromé. Le produit est aussi disponible dans la version avec LED SMD multi-chip, lumière blanche naturelle.

Luminaria de luz difusa. Estructura de cristal satinado blanco o ambar, complementos en metal cromado. Disponible tambien con LED SMD multi-chip a luz blanca natural.

Modelli depositati / Patent pending



Ambra



Bianco

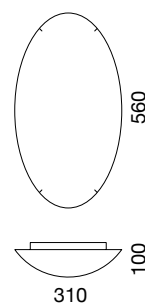
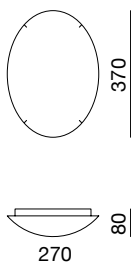
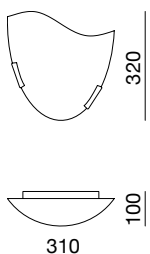

elettrificazione	colore	codice
2xE14 28W	Bianco	M103.1
1xLED SMD 9W 4500K	Bianco	M103.11
2xE14 28W	Ambra	M103.3
1xLED SMD 9W 4500K	Ambra	M103.13

IP 20

elettrificazione	colore	codice
2xE14 28W	Bianco	M103.4
LED SMD 11W 4500K	Bianco	M103.14
2xE14 28W	Ambra	M103.5
LED SMD 11W 4500K	Ambra	M103.15

IP 20

elettrificazione	colore	codice
2xE27 52W	Bianco	M103.6
LED SMD 15.4W 4500K	Bianco	M103.16
2xE27 52W	Ambra	M103.8
LED SMD 15.4W 4500K	Ambra	M103.18

IP 20



M103.6



M103.4

ONDA

Design Federico Codato

LED
SMD



Lampade a luce diffusa. Diffusore in vetro bianco satinato o ambra, particolare in metallo cromato o ottonato. Disponibile anche con illuminazione a LED SMD multi-chip a luce bianca naturale.

Lamp giving diffused light. White or amber satin glass diffuser, chromed or brassed metal details. Also available with multi-chip SMD LED natural white light.

Lampe mit diffusem Licht. Glas Diffusor weiß satiniert oder amber, Metall Details verchromt oder vermessingt. Die Leuchte ist auch mit LED SMD multi-chip erhältlich, weiß Tageslicht.

Lampe à lumière diffuse. Diffuseur en verre blanc satiné ou ambre, détails en métal chromé ou laiton. Le produit est aussi disponible dans la version avec LED SMD multi-chip, lumière blanche naturelle.

Luminaria de luz difusa. Estructura de cristal satinado blanco o ambar, complementos de metal cromado ó latonado. Disponible tambien con LED SMD multi-chip a luz blanca natural.



Ambra



Bianco

Modelli depositati / Patent pending

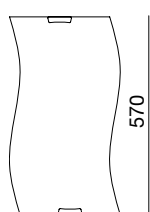

elettrificazione		colore	codice
4xE14 42W		Ambra	M120.1
2x2G11 36W		Ambra	M120.2
LED SMD 15.4W 4500K		Ambra	M120.11
4xE14 42W		Bianco	M120.3
2x2G11 36W		Bianco	M120.4
LED SMD 15.4W 4500K		Bianco	M120.13

IP 20



M120.3



M120.1

SCACCHI

Design Ufficio Tecnico

LED
SMD



Lampade a luce diffusa. Diffusore in vetro decorato, particolari in metallo cromato o ottonato. Disponibile anche con illuminazione a LED SMD multi-chip a luce bianca naturale.

Lamp giving diffused light. Decorated glass diffuser, chromed or brassed metal details. Also available with multi-chip SMD LED natural white light.

Lampe mit diffusem Licht. Dekorierter Glas Diffusor; Metall Details verchromt oder vermessingt. Die Leuchte ist auch mit LED SMD multi-chip erhältlich, weiß Tageslicht.

Lampe à lumière diffuse. Diffuseur en verre décoré, détails en métal chromé ou laiton. Le produit est aussi disponible dans la version avec LED SMD multi-chip, lumière blanche naturelle.

Luminaria de luz difusa. Difusor de cristal decorado, complementos en metal cromado ó latonado. Disponible tambien con LED SMD multi-chip a luz blanca natural.

Modelli depositati / Patent pending



Ambra



Bianco

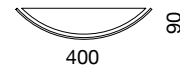
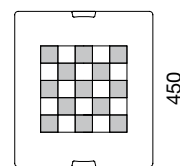
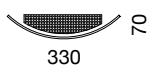
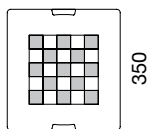
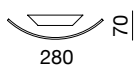
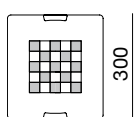

elettrificazione	colore	codice
2xE14 42W	Ambra	M128.3
2xG23 9W	Ambra	M128.4
1xLED SMD 9W 4500K	Ambra	M128.23
2xE14 42W	Bianco	M128.5
2xG23 9W	Bianco	M128.6
1xLED SMD 9W 4500K	Bianco	M128.25

IP 20

elettrificazione	colore	codice
2xE14 42W	Ambra	M128.7
2x2G11 18W	Ambra	M128.8
1xLED SMD 9W 4500K	Ambra	M128.27
2xE14 42W	Bianco	M128.10
2x2G11 18W	Bianco	M128.11
1xLED SMD 9W 4500K	Bianco	M128.30

IP 20

elettrificazione	colore	codice
4xE27 42W	Ambra	M128.13
4x2G11 24W	Ambra	M128.15
1xLED SMD 19W 4500K	Ambra	M128.33
4xE27 42W	Bianco	M128.16
4x2G11 24W	Bianco	M128.18
1xLED SMD 19W 4500K	Bianco	M128.36

IP 20



RODEO

Design Ufficio Tecnico

Lampade a luce diffusa. Struttura in metallo verniciato, diffusore in vetro bianco o colorato satinato.

Lamps giving diffused light. Metal frame painted, satin glass diffuser available in white or in different colours.

Lampen mit diffusem Licht. Struktur aus lackiertem Metall, Glas-Diffusor weiß oder farbig satiniert.

Collection de lampes à lumière diffuse. Structure en métal vernisé. Diffuseur en verre satiné disponible en blanc ou en différents couleurs.

Luminaria de luz difusa. Estructura de metal pintado, difusor de cristal blanco ó de color satinado.



Bianco



Ambra

Modelli depositati / Patent pending

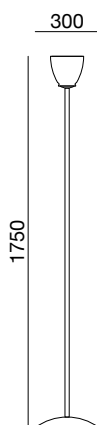
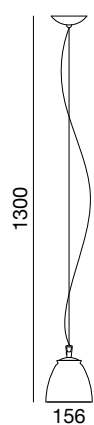

elettrificazione	colore	codice
1xE27 42W	Bianco	G1090.14
1xE27 42W	Ambra	G1090.17

IP 20

elettrificazione	colore	codice
1xE27 105W	Bianco	G1090.18
1xE27 105W	Ambra	G1090.21

dimmer IP 20

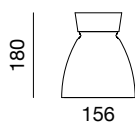
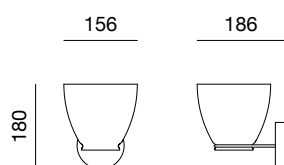

elettrificazione	colore	codice
1xE27 52W	Bianco	G1090.01
1xE27 52W	Ambra	G1090.04

IP 20

elettrificazione	colore	codice
1xE27 42W	Bianco	G1090.09
1xE27 42W	Ambra	G1090.12

IP 20





G1090.12



G1090.04

COMETA

Design Roberto Favaretto

LED
SMD



Serie di lampade a luce diffusa da parete, tavolo, terra, sospensione e soffitto. Struttura in metallo cromato, diffusore in cristalli 30% PbO sfaccettati. Disponibile anche con illuminazione a LED SMD multi-chip a luce bianca naturale.

Range of wall, table, floor and pendant lamps giving diffused light. Metal frame in chrome finish. Diffuser with faceted 30% PbO crystals. Also available with multi-chip SMD LED natural white light.

Leuchten Serie mit Streulicht für Wand-, Tisch-, Steh-, Decken- und Hängeleuchte, Metallarmatur chrom. Diffusor aus facettiertem 30% PbO Kristall. Die Leuchte ist auch mit LED SMD multi-chip erhältlich, weiß Tageslicht.

Collection d'appliques, lampes de table, lampadaires et suspensions à lumière diffuse. Structure en métal, finition chromée. Diffuseur avec des cristal 30% PbO facettés. Le produit est aussi disponible dans la version avec LED SMD multi-chip, lumière blanche naturelle.

Serie de lámparas de luz difusa de pared, mesa, de pie, suspensión y techo. Estructura de metal cromado, difusor de cristal 30% PbO facetado. Disponible tambien con LED SMD multi-chip a luz blanca natural.



Cromo



Bianco

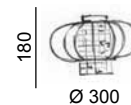
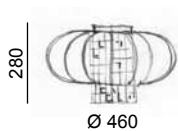
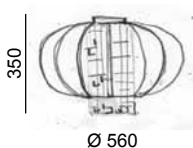

elettrificazione	colore	codice
1xE27 105W	Cromo	G1809.06
1xE27 105W	Bianco	G1809.16
1xLED SMD 15W 4500K	Cromo	G1809.26
1xLED SMD 15W 4500K	Bianco	G1809.36

IP 20 V CE

elettrificazione	colore	codice
1xE27 70W	Cromo	G1809.07
1xE27 70W	Bianco	G1809.17
1xLED SMD 9W 4500K	Cromo	G1809.27
1xLED SMD 9W 4500K	Bianco	G1809.37

IP 20 V CE

elettrificazione	colore	codice
1xE14 42W	Cromo	G1809.08
1xE14 42W	Bianco	G1809.18

IP 20 V CE

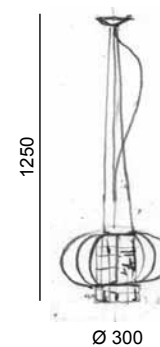
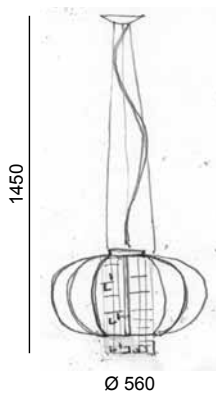
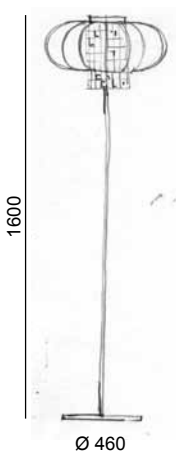

elettrificazione	colore	codice
1xE27 105W	Cromo	G1809.04
1xE27 105W	Bianco	G1809.14

dimmer IP 20 V CE

elettrificazione	colore	codice
1xE27 105W	Cromo	G1809.01
1xE27 105W	Bianco	G1809.11
1xLED SMD 15W 4500K	Cromo	G1809.21
1xLED SMD 15W 4500K	Bianco	G1809.31

IP 20 V CE

elettrificazione	colore	codice
1xE14 42W	Cromo	G1809.02
1xE14 42W	Bianco	G1809.12

IP 20 V CE

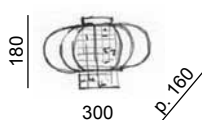
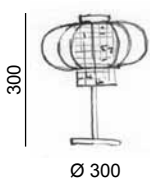

elettrificazione	colore	codice
1xG9 48W	Cromo	G1809.03
1xG9 48W	Bianco	G1809.13

IP 20 V CE

elettrificazione	colore	codice
1xG9 48W	Cromo	G1809.05
1xG9 48W	Bianco	G1809.15
1xLED SMD 2.9W 4500K	Cromo	G1809.25
1xLED SMD 2.9W 4500K	Bianco	G1809.35

IP 20 V CE



G1809.01







G1809.07



G1809.08



G1809.05

G1809.04



G1809.03

PRISMA

Design Officina San Marco

Collezione di lampade da tavolo, terra, parete e sospensione. La luce si diffonde tra eleganti cristalli al PbO 30% e un' essenziale struttura metallica cromata.





Collection of lamps giving diffuse light, available as a pendant, wall, table and floor lamp. The light filters through a cascade of PbO 30% crystals; clean yet elegant polished chrome metal frame.

Kollektion von Hänge-, Wand-, Tisch- und Standleuchten mit diffusem Licht. Das Licht dringt durch eine Kaskade von PbO 30% Kristallen; einfache aber zugleich elegante verchromte Armatur.

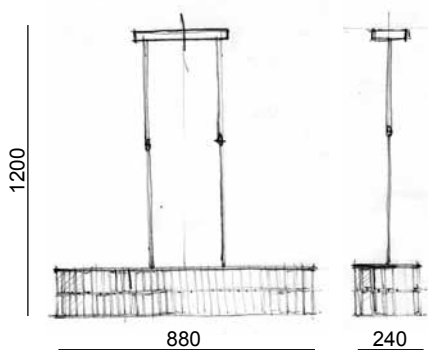



Collection d'appliques, lampes de table, lampadaires et suspension à lumière diffuse. La lumière filtre à travers des cristaux en PbO 30%; monture en chromé brillant au design essentiel mais élégant au même temps.

Serie de lámpara de luz difusa de pared, mesa, de pie y suspensión. La cascada de cristales PbO 30% crean interesantes efectos de transparencia y difusos; la estructura de metal cromado es simple pero muy elegante al mismo tiempo.

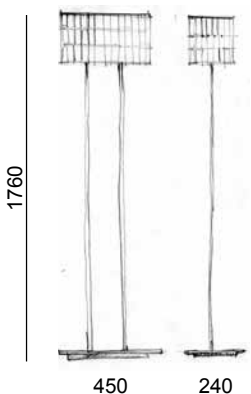





elettrificazione	colore	codice
5xG9 33W 	Cromo	S4167.01
   		

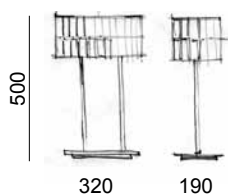





elettrificazione	colore	codice
3xG9 33W 	Cromo	S4167.05
   		

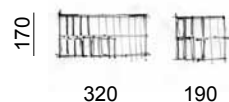

elettrificazione	colore	codice
3xG9 33W 	Cromo	S4167.03
   		



elettrificazione	colore	codice
2xG9 33W 	Cromo	S4167.07
   		



S4167.03



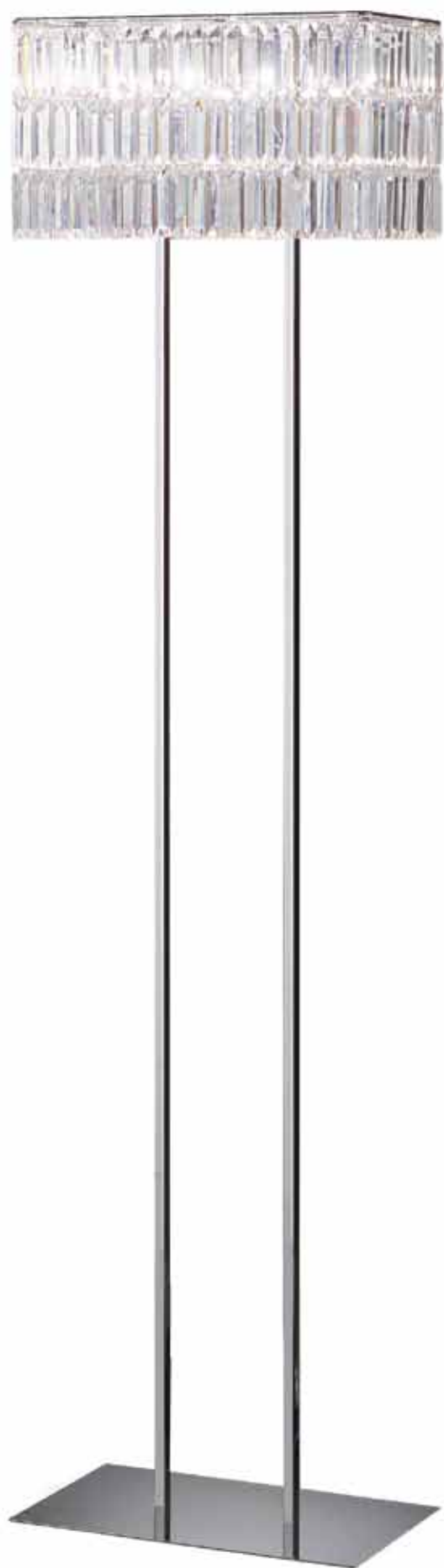

S4167.05

BUCINTORO

Design Officina San Marco

Collezione di lampade da terra, tavolo, parete e sospensione: un incantevole effetto di luce tra gocce in cristallo 30%PbO dolcemente incastonate in una maglia metallica dorata, cromata o bianca.

Collection of lamps giving diffuse light, available as a pendant, wall, table and floor lamp. A beautiful light effect is given by 30%PbO crystal drops mounted on a metal mesh frame available in chrome, gold or white.

Kollektion von Hänge-, Wand-, Tisch- und Standleuchten mit diffusum Licht. Die stilvollen PbO 30% Kristallen werden in einer Metall-Gliederarmatur gelegt. Ausführung: chrom, gold oder weiß.

Collection d'applique, lampadaire, lampe à poser et suspension à lumière diffuse. Les raffinés crystals en PbO 30% doucement montés dans une maille, disponible chromée, dorée ou blanche, créent un charmant effet de lumière.

Serie de lámpara de luz difusa de pared, mesa, de pie y suspensión. La cascada de cristales PbO 30% crean interesantes efectos de transparencia y difusos, que ponen en evidencia los preciosos acabados en oro, cromo ó blanco de la estructura de metal.



Cromo



Oro



Bianco

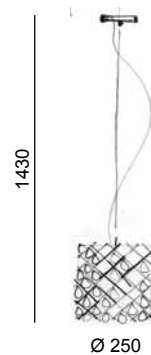
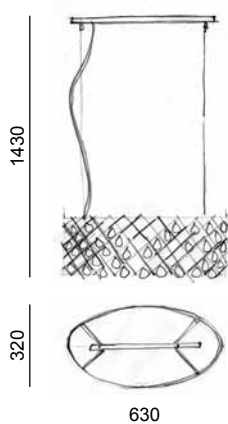
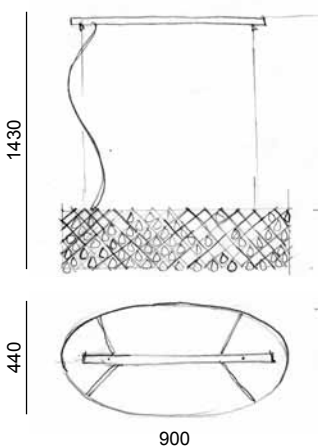

elettrificazione	colore	codice
5xG9 33W	Cromo	S4181.01
5xG9 33W	Oro	S4181.02
5xG9 33W	Bianco	S4181.21



elettrificazione	colore	codice
4xG9 33W	Cromo	S4181.03
4xG9 33W	Oro	S4181.04
4xG9 33W	Bianco	S4181.22



elettrificazione	colore	codice
1xE27 42W	Cromo	S4181.05
1xE27 42W	Oro	S4181.06
1xE27 42W	Bianco	S4181.23

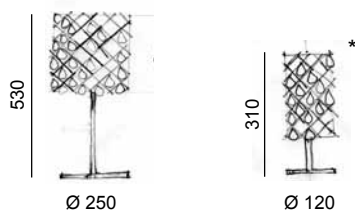
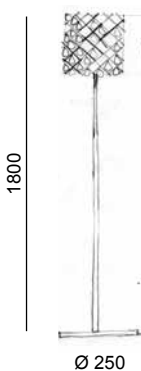

elettrificazione	colore	codice
1xE27 42W	Cromo	S4181.07
1xE27 42W	Oro	S4181.08
1xE27 42W	Bianco	S4181.24
1xE14 42W	Cromo	S4181.09*
1xE14 42W	Oro	S4181.10*
1xE14 42W	Bianco	S4181.25*

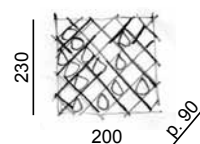

elettrificazione	colore	codice
1xE27 42W	Cromo	S4181.11
1xE27 42W	Oro	S4181.12
1xE27 42W	Bianco	S4181.26



elettrificazione	colore	codice
2xG9 33W	Cromo	S4181.13
2xG9 33W	Oro	S4181.14
2xG9 33W	Bianco	S4181.27







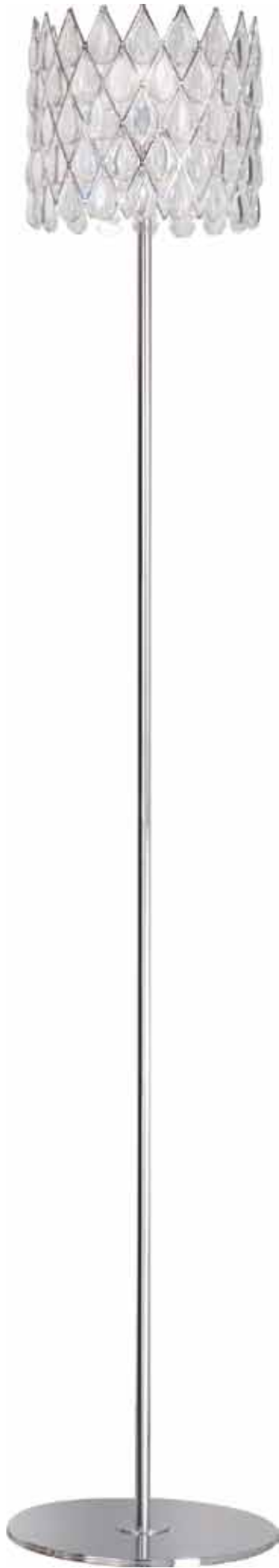

S4181.11



RONDÒ

Design Roberto Favaretto

Collezione di lampade da tavolo, terra, parete e sospensione. La luce si diffonde attraverso eleganti paralumi in pongé interamente plissettati a mano e si completa con i riflessi suggestivi dei pendenti in cristallo al PbO 30%, incastonati nella struttura in metallo verniciato bianco con particolari in cromo.

Collection of lamps giving diffuse light, available as a pendant, wall, table and floor lamp. The smart effects of transparencies and flashes are given by a choice of elegant lampshades in pongé fabric and fine PbO 30% crystal drops. White painted metal frame with polished chrome details.

Kollektion von Hänge-, Wand-, Tisch- und Standleuchten mit diffusem Licht. Eleganter Lampenschirm aus Pongé mit einer Kaskade von kleinen PbO 30% Kristallen, welche eindrucksvolle Spiele von Transparenzen und diffusen Schimmern anbieten. Armatur aus verchromtem Metall, Basis lackiert.

Collection de lampes à lumière diffuse (applique, suspension, lampe à poser et lampadaire). L'élégante paralume en pongé avec un jeu de cristaux facettés PbO 30% créent des effets de transparence et de lueurs. Monture en métal chromé avec base vernisée blanc.

Serie de lámpara de luz difusa de pared, mesa, de pie y suspensión. Estructura de metal cromado, base pintada. Difusor de pongé y cristal facetado al 30% PbO, que crean interesantes efectos de transparencia y difusos.

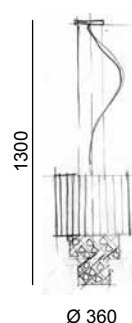
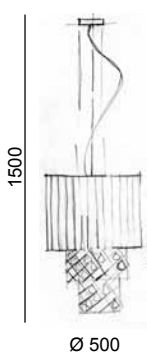
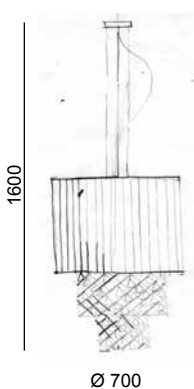

elettrificazione	colore	codice
3xE27 42W + 4xE14	Bianco	S4204.01
	IP 20	VF ⊕ CE

elettrificazione	colore	codice
3xE27 42W + 4xE14	Bianco	S4204.02
	IP 20	VF ⊕ CE

elettrificazione	colore	codice
3xE14 28W + 4xG9 33W	Bianco	S4204.03
	IP 20	VF ⊕ CE

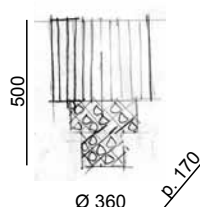
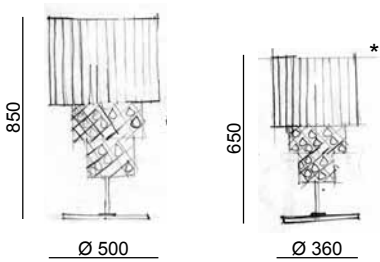
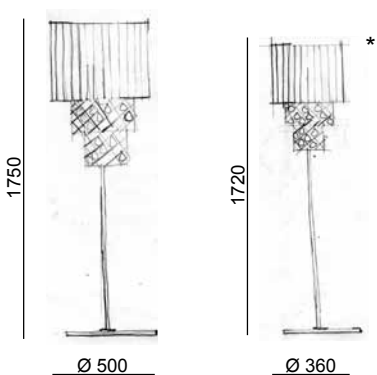

elettrificazione	colore	codice
3xE27 42W + 3xE14	Bianco	S4204.06
3xE14 28W + 4xG9 33W	Bianco	S4204.07*
dimmer	IP 20	VF ⊕ CE

elettrificazione	colore	codice
3xE27 42W + 3xE14	Bianco	S4204.04
3xE14 28W + 4xG9 33W	Bianco	S4204.05*
dimmer	IP 20	VF ⊕ CE

elettrificazione	colore	codice
3xE14 28W	Bianco	S4204.08
	IP 20	VF ⊕ CE



S4204.08





S4204.05



S4204.06

DUCALE

Design Roberto Favaretto

Collezione di lampade da parete e sospensione. La luce viene diffusa da eleganti paralumi bianco o nero in pongé plissettati a mano, abbinati alla trasparenza dei pendenti in cristallo al PbO30%. Struttura in metallo verniciato bianco e cromo.

Collection of lamps giving diffuse light, available as a pendant and wall lamp. The smart effects of transparencies and flashes are given by a choice of elegant lampshades in pongé fabric and fine PbO 30% crystal drops. White painted metal frame with polished chrome details.

Kollektion von Hänge- und Wandleuchten mit diffusem Licht. Eleganter Lampenschirm aus Pongé (weiß oder schwarz) mit einer Kaskade von kleinen PbO 30% Kristallen, welche eindrucksvolle Spiele von Transparenzen und diffusen Schimmern anbieten. Armatur aus verchromtem Metall, Basis lackiert.

Collection de lampes à lumière diffuse (applique et suspension). L'élégante paralume en pongé disponible en noir ou blanc avec un jeu de cristaux facettés PbO 30% créent des effets de transparence et de lueurs. Monture en métal chromé avec base vernisée blanc.

Serie de lámpara de luz difusa de pared, y suspensión. Estructura de metal cromado, base pintada. Difusor de pongé (blanco ó negro) y cristal facetado al 30% PbO, que crean interesantes efectos de transparencia y difusos.



Bianco



Nero

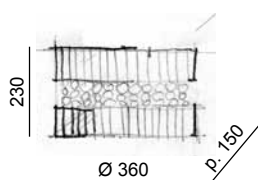
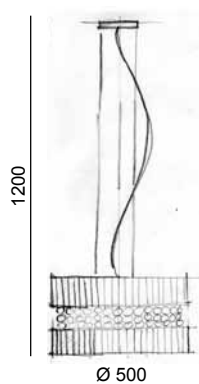

elettrificazione	colore	codice
6xG9 33W	Bianco	S4206.03
6xG9 33W	Nero	S4206.04



elettrificazione	colore	codice
2xG9 33W	Bianco	S4206.13
2xG9 33W	Nero	S4206.14







S4206.13





RIALTO

Design Roberto Favaretto

LED
SMD



Collezione di lampade da tavolo, terra, parete e sospensione. La luce viene diffusa da eleganti paralumi bianco o nero, in pongé plissettati a mano abbinati alla trasparenza dei pendenti in cristallo al PbO 30%. Struttura in metallo verniciato bianco e cromo. Disponibile anche con illuminazione a LED SMD multi-chip a luce bianca naturale.

Collection of lamps giving diffuse light, available as a pendant, wall, table and floor lamp. The smart effects of transparencies and flashes are given by a choice of elegant lampshades in pongé fabric and fine PbO 30% crystal drops. White painted metal frame with polished chrome details. Also available with multi-chip SMD LED natural white light.

Kollektion von Hänge-, Wand-, Tisch- und Standleuchten mit diffusem Licht. Eleganter Lampenschirm aus Pongé (weiß oder schwarz) mit einer Kaskade von kleinen PbO 30% Kristallen, welche eindrucksvolle Spiele von Transparenzen und diffusen Schimmern anbieten. Armatur aus verchromtem Metall, Basis lackiert. Die Leuchte ist auch mit LED SMD multi-chip erhältlich, weiß Tageslicht.

Collection de lampes à lumière diffuse (applique, suspension, lampe à poser et lampadaire). L'élégante paralume en pongé disponible en noir ou blanc avec un jeu de cristaux facettés PbO 30% créent des effets de transparence et de lueurs. Monture en métal chromé avec base vernisée blanc. Le produit est aussi disponible dans la version avec LED SMD multi-chip, lumière blanche naturelle.

Serie de lámpara de luz difusa de pared, mesa, de pie y suspensión. Estructura de metal cromado, base pintada. Difusor de pongé (blanco ó negro) y cristal facetado al 30% PbO, que crean interesantes efectos de transparencia y difusos. Disponible tambien con LED SMD multi-chip a luz blanca natural.



Bianco



Nero

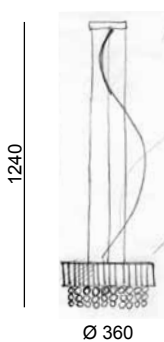
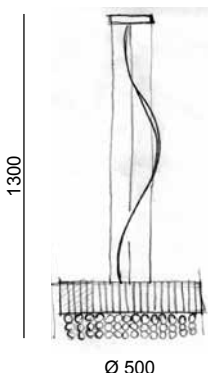

elettrificazione	colore	codice
6xG9 33W	Bianco	S4209.03
6xG9 33W	Nero	S4209.04
1xLED SMD 19W 4500K	Bianco	S4209.23
1xLED SMD 19W 4500K	Nero	S4209.24

IP 20

elettrificazione	colore	codice
3xG9 33W	Bianco	S4209.05
3xG9 33W	Nero	S4209.06
1xLED SMD 15W 4500K	Bianco	S4209.25
1xLED SMD 15W 4500K	Nero	S4209.26

IP 20

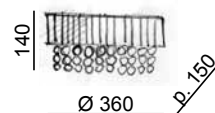
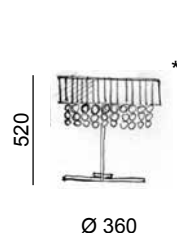
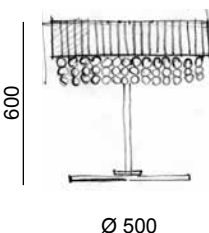
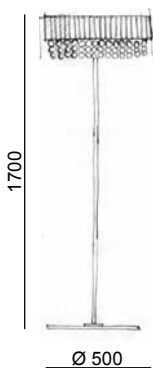

elettrificazione	colore	codice
6xG9 33W	Bianco	S4209.11
6xG9 33W	Nero	S4209.12

IP 20

elettrificazione	colore	codice
6xG9 33W	Bianco	S4209.07
6xG9 33W	Nero	S4209.08
3xG9 33W	Bianco	S4209.09*
3xG9 33W	Nero	S4209.10*

IP 20

elettrificazione	colore	codice
2xG9 33W	Bianco	S4209.13
2xG9 33W	Nero	S4209.14
LED SMD 5.5W 4500K	Bianco	S4209.33
LED SMD 5.5W 4500K	Nero	S4209.34

IP 20



S4209.11

S4209.04





S4209.14



S4209.10

REGALE

Design Roberto Favaretto

Collezione di lampade da tavolo, terra, parete e sospensione. La luce filtra attraverso i cristalli al PbO 30% creando degli effetti colorati che si riflettono sulla struttura in metallo cromato.

Collection of lamps giving diffuse light, available as a pendant, wall, table and floor lamp. The light filters through a cascade of PbO 30% crystals, creating unique effects on the polished chrome metal frame.

Kollektion von Hänge-, Wand-, Tisch- und Standleuchten mit diffusem Licht. Das Licht dringt durch eine Kaskade von PbO 30% Kristallen und strahlt auf die verchromte Armatur mit einzigen farbigen Effekten zurück.

Collection d'appliques, lampes de table, lampadaires et suspension à lumière diffuse. La lumière filtre à travers des cristaux en PbO 30%, en créant au même temps des effets de couleur qui se réfléchissent sur la monture en chromé brillant.

Serie de lámpara de luz difusa de pared, mesa, de pie y suspensión. La cascada de cristales PbO 30% crean interesantes efectos de transparencia y difusos, que se refleja sobre la estructura de metal cromado.

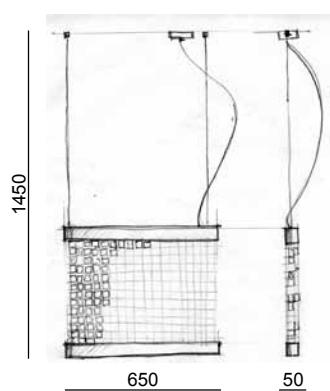

elettrificazione	colore	codice
8xG9 33W	Cromo	S4208.01

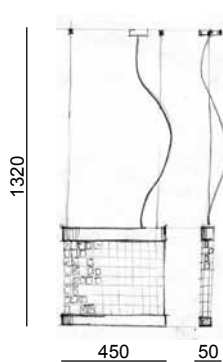

elettrificazione	colore	codice
6xG9 33W	Cromo	S4208.02

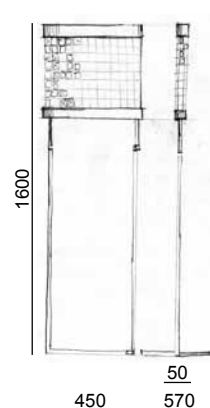

elettrificazione	colore	codice
6xG9 33W	Cromo	S4208.05

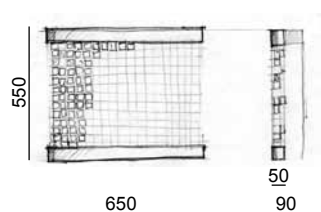

elettrificazione	colore	codice
8xG9 33W	Cromo	S4208.06

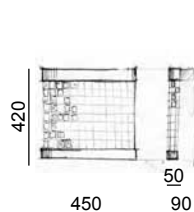

elettrificazione	colore	codice
6xG9 33W	Cromo	S4208.07

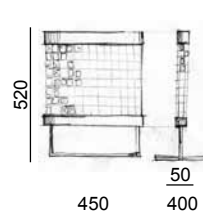

elettrificazione	colore	codice
6xG9 33W	Cromo	S4208.04



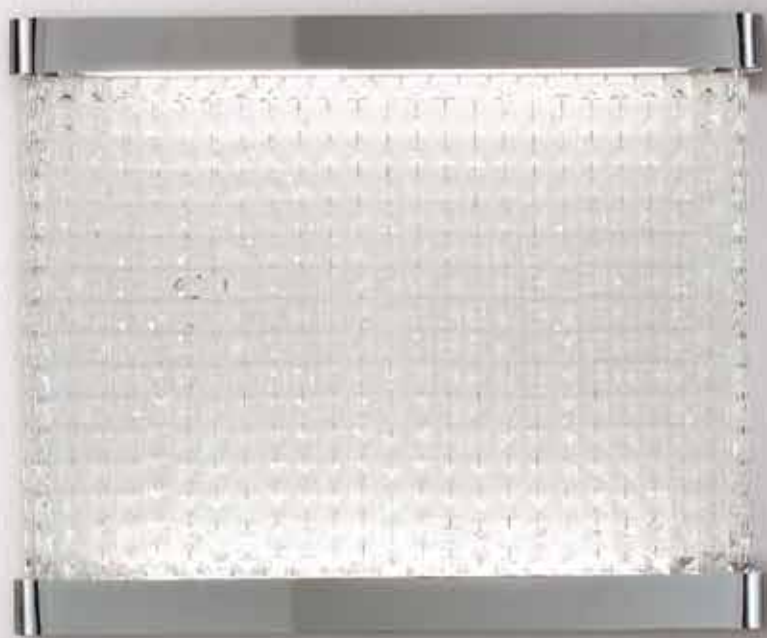



S4208.02



S4208.04

CA' D'ORO

Design Officina San Marco

Collezione di lampade a soffitto e parete; una dolce composizione di cristalli al PbO30% abbinata ad una originale struttura metallica dorata o cromata.

Collection of lamps giving diffuse light, available as a ceiling or wall lamp. A beautiful light effect is given by 30%PbO crystal drops mounted on an original metal frame available in chrome or gold.

Kollektion von Decken- und Wandleuchten mit diffusem Licht. Eine stillvolle Zusammensetzung von PbO 30% Kristallen mit einer originellen Armatur aus Metall. Ausführung: chrom oder gold.

Collection d'appliques et plafonniers à lumière diffuse. Les crystals en PbO 30% doucement montés dans une originelle monture en métal créent une élégante composition. Disponible chromée ou dorée.

Serie de lámpara de luz difusa de pared y de techo. La cascada de cristales PbO 30% crean interesantes efectos de transparencia y difusos, que ponen en evidencia los preciosos acabados en oro o cromo de la estructura de metal.



Oro



Cromo

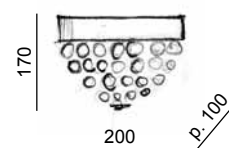
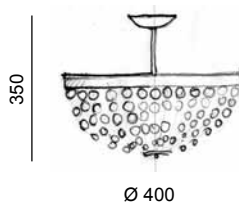
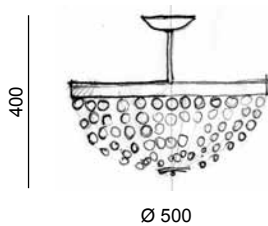

elettrificazione	colore	codice
6xE14 28W	Oro	S4220.01

elettrificazione	colore	codice
4xE14 28W	Oro	S4220.03
4xE14 28W	Cromo	S4220.04

elettrificazione	colore	codice
2xE14 28W	Oro	S4220.05
2xE14 28W	Cromo	S4220.06







S4220.04

ISOLA

Design Officina San Marco

Collezione di lampade da parete e sospensione. La luce viene diffusa da eleganti vetri in cristallo trasparente che assieme ai pendenti in cristallo vestono una semplice struttura rivestita in oro o nichel perlato.

Collection of pendant and wall lamps. The light is diffused by elegant crystal glass diffusers and crystal drops, emphasizing a simple metal frame available in pearly gold or pearly nickel.

Kollektion von Hänge und Wandleuchten. Das Licht dringt durch elegante Kristallgläser und Kristalltropfen, welche die wertvollen Ausführungen in Perlgold und Perlnickel der Metallarmatur hervorheben.

Collection d'appliques et suspensions à lumière diffuse. La lumière filtre à travers des verres transparents en crystal et des gouttes en crystal qui font ressortir les précieuses finitions en or perle et en nickel perle de la monture en métal.

Serie de lámpara de luz difusa de pared y suspensión. Difusor de pongé o algodón alternado con el difusor de cristal 30% PbO facetado. Estructura de metal con acabados en oro y niquel perlado; difusor de cristal transparente y cristal facetado.



Nichel Perlato



Oro Perlato

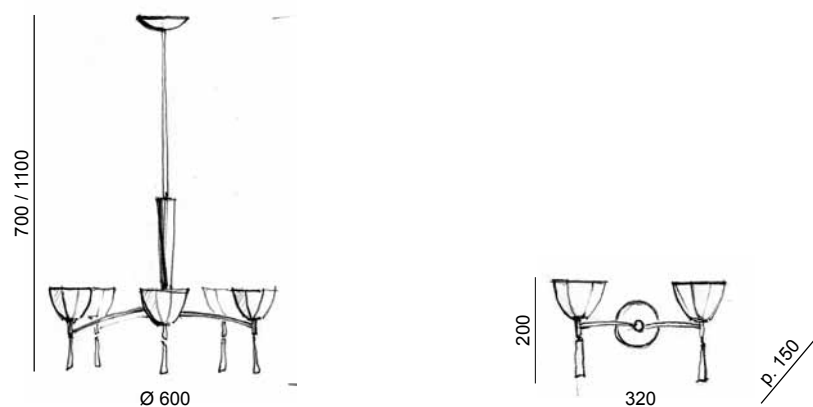

elettrificazione	colore	codice
5xG9 33W	Nichel Perlato	S4123.01
5xG9 33W	Oro Perlato	S4123.02



elettrificazione	colore	codice
2xG9 33W	Nichel Perlato	S4123.03
2xG9 33W	Oro Perlato	S4123.04









TORCELLO

Design Officina San Marco

Collezione di lampade da terra, tavolo, parete e sospensioni. La struttura in metallo oro o nichel opaco è interamente rivestita di foglie, decorata con fiori verniciati nero opaco e addolcita da paralumi neri appoggiati a raffinate bobèches in cristallo al PbO30% trasparenti.

Collection of lamps giving diffuse light, available as a pendant, wall, table and floor lamp. Metal frame available in gold or matt nickel decorated with leaves and flowers painted in matt black. Black lampshades and fine bobèches in transparent 30% Pbo crystal.

Kollektion von Hänge-, Wand-, Tisch- und Standleuchten. Metallarmatur geschmückt mit Blättern und Blumen, welche in matt schwarz lackiert werden. Schwarze Lampenschirmen und raffinierte Bobèches aus Kristall PbO 30%. Ausführung gold oder matt nickel.

Collection d'applique, lampadaire, lampe à poser et suspension à lumière diffuse. La monture en métal est disponible dans la finition or ou nickel matt. La collection présente une particulière décoration florale avec des feuilles et des roses en noir matt. Des paralumes noirs et des bobèches en crystal Pbo 30% rendent la collection très élégante.

Serie de lámpara de luz difusa de pared, mesa, de pie y suspensión. Estructura de metal con acabados en oro o niquel mate, difusor de pongé negro y bobèches de cristal facetado al 30% PbO. Decorado con hojas y flores en negro mate.



Oro Opaco



Nikel Opaco

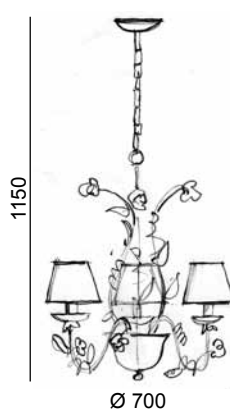
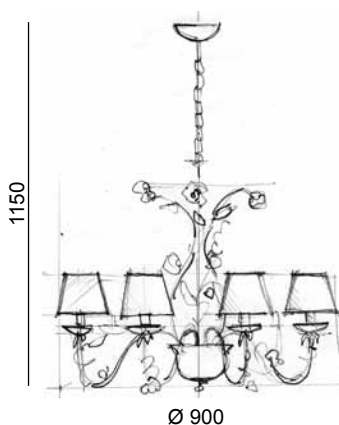

elettrificazione	colore	codice
8xE14 42W	Oro Opaco	S4183.01
8xE14 42W	Nikel Opaco	S4183.02

IP 20 V ⊕ CE

elettrificazione	colore	codice
6xE14 42W	Oro Opaco	S4183.03
6xE14 42W	Nikel Opaco	S4183.04

IP 20 V ⊕ CE

elettrificazione	colore	codice
5xE14 42W	Oro Opaco	S4183.13
5xE14 42W	Nikel Opaco	S4183.14

IP 20 V ⊕ CE

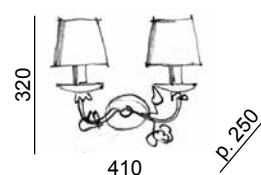
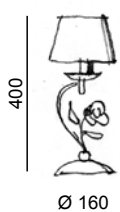
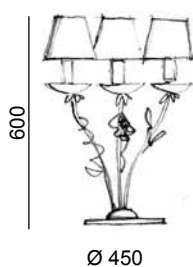

elettrificazione	colore	codice
3xE14 42W	Oro Opaco	S4183.09
3xE14 42W	Nikel Opaco	S4183.10

IP 20 V ⊕ CE

elettrificazione	colore	codice
1xE14 42W	Oro Opaco	S4183.11
1xE14 42W	Nikel Opaco	S4183.12

IP 20 V ⊕ CE

elettrificazione	colore	codice
2xE14 42W	Nikel Opaco	S4183.08

IP 20 V ⊕ CE





S4183.10

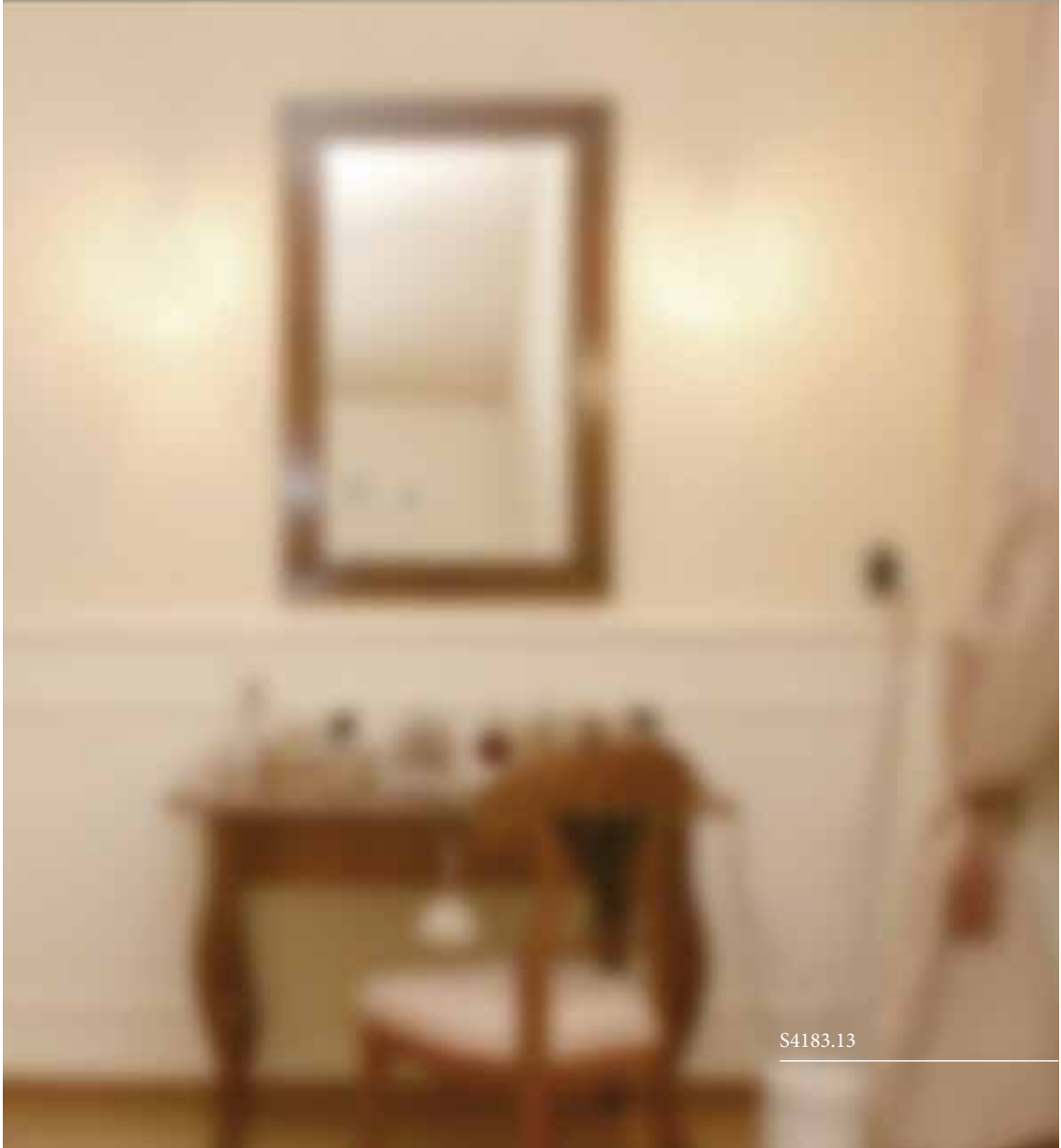

S4183.13

RIO

Design Officina San Marco

Collezione di lampade da terra, tavolo, parete e sospensione. Forme ampie e semplici personalizzate da raffinati paralumi in organza e/o cotone con dettagli in cristallo al PbO30% che vanno a completare un'essenziale struttura in metallo cromato.

Collection of lamps giving diffuse light, available as a pendant, wall, table and floor lamp. Characterized by clean yet elegant design, they come with fine lampshades in organza fabric and/or in cotton with details in PbO 30% crystals. Chromed metal frame.

Kollektion von Hänge-, Wand-, Tisch- und Standleuchten mit einfachem aber elegantem Design. Raffinierte Lampenschirmen aus Organza und/oder Baumwollstoff mit Details aus Kristall PbO 30%. Verchromte Metallarmatur.

Collection d'applique, lampadaire, lampe à poser et suspension à lumière diffuse. Crystals en PbO 30% doucement montés dans une monture essentielle en métal chromée avec des paralumes en organza et/ou en coton.

Serie de lámpara de luz difusa de pared, mesa, de pie y suspensión. Difusor de pongé o algodón alternado con el difusor de cristal 30% PbO facetado; estructura de metal cromado.

Ordinare codice struttura + codice paralume / Order frame code + shade code / bestellen Artikelnummer Struktur + Artikelnummer Schirm / Commander code structure + code paralume / Pedir código estructura + código pantalla

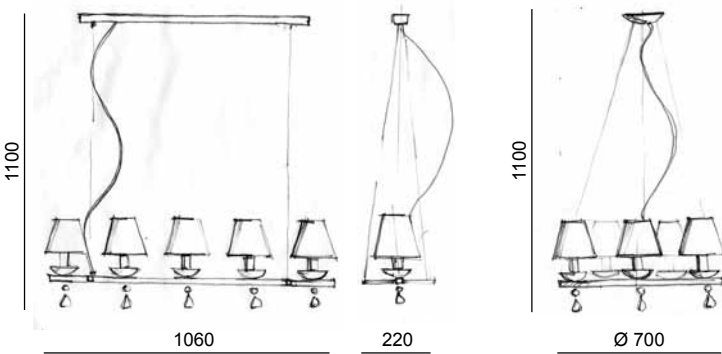

elettrificazione	colore	codice
5xE14 42W	Cromo	S4158.01



elettrificazione	colore	codice
6xE14 42W	Cromo	S4158.02

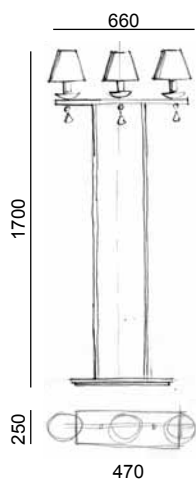

elettrificazione	colore	codice
3xE14 42W	Cromo	S4158.05

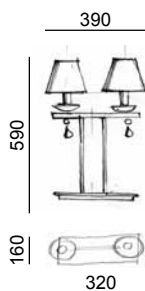

elettrificazione	colore	codice
2xE14 42W	Cromo	S4158.04

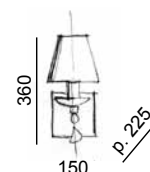

elettrificazione	colore	codice
1xE14 42W	Cromo	S4158.03



Organza Plissé Nero
480034



Pongé Plissé Avorio
480035



Pongé Plissé Bianco
480036



Pongé Plissé Fucsia
480037



Pongé Plissé Rosso
480038



S4158.02 + 6x480036





S4158.04 + 2x480038



PISANI

Design Officina San Marco

Collezione di lampade da terra, tavolo, parete e sospensioni. La struttura metallica in un originale abbinamento tra oro lucido e perlato, oppure nichel lucido e perlato. Una linea romantica completata dalle bobèches in cristallo al PbO30% e i paralumi disponibili in vari colori.

Collection of lamps giving diffuse light, available as a pendant, wall, table and floor lamp. Metal frame with an original finish in polished gold combined with pearly gold or polished nickel combined with pearly nickel. Elegant 30% PbO bobèches with a choice of lampshades available in different colours.

Kollektion von Hänge-, Wand-, Tisch- und Standleuchten. Metallarmatur, Ausführung Gold glänzend mit Perlgold oder Nickel glänzend mit Perlnickel. Raffinierte Bobèches aus 30% Pbo Kristall mit eleganten Lampenschirmen, verfügbar in verschiedenen Farben.

Collection d'applique, lampadaire, lampe à poser et suspension à lumière diffuse. Monture en métal caractérisée par une finition très originale: or brillant et or perle ou nickel brillant et nickel perle. Des paralumes disponibles en différentes couleurs et des bobèches en crystal Pbo 30% rendent la collection très élégante.

Serie de lámpara de luz difusa de pared, mesa, de pie y suspensión. Estructura de metal disponible en acabado oro brillante y oro perlado o bien níquel brillante y nickel perlado. Difusor de cristal 30% PbO. Accesorios: difusor de pongé disponible en varios colores.

Ordinare codice struttura + codice paralume / Order frame code + shade code / bestellen Artikelnummer Struktur + Artikelnummer Schirm / Commander code structure + code paralume / Pedir código estructura + código pantalla

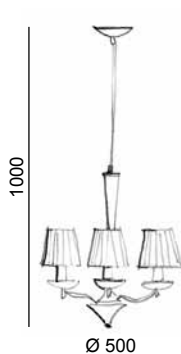
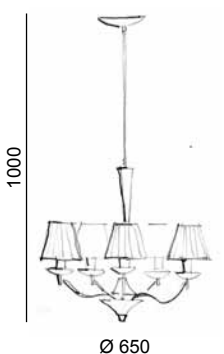

elettrificazione	colore	codice
8xE14 42W		Oro Perlato S3988.19
8xE14 42W		Nikel Perlato S3988.20

IP 20

elettrificazione	colore	codice
5xE14 42W		Oro Perlato S3988.21
5xE14 42W		Nikel Perlato S3988.22

IP 20

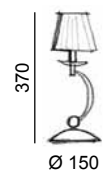
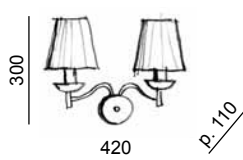
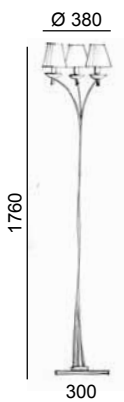

elettrificazione	colore	codice
3xE14 42W		Oro Perlato S3988.27
3xE14 42W		Nikel Perlato S3988.28

IP 20

elettrificazione	colore	codice
2xE14 42W		Oro Perlato S3988.23
2xE14 42W		Nikel Perlato S3988.24

IP 20

elettrificazione	colore	codice
1xE14 42W		Oro Perlato S3988.25
1xE14 42W		Nikel Perlato S3988.26

IP 20



Oro Perlato



Nikel Perlato



Organza Plissé Nero 480034



Pongé Plissé Avorio 480035



Pongé Plissé Bianco 480036



Pongé Plissé Fucsia 480037



Pongé Plissé Rosso 480038







S3988.24 + 2x480036



S3988.25 + 1x480035

FENICE

Design Officina San Marco

Collezioni di lampade a sospensione e parete. Una struttura armoniosa, dorata o cromata; una linea elegante, impreziosita da raffinati cristalli al PbO30%: il tutto si può personalizzare con originali paralumi disponibili in vari colori.

Collection of pendant and wall lamps characterized by clean yet elegant design. The metal frame is available in a gold or chrome finish with fine 30% PbO crystal diffusers. On request original lampshades in a choice of different colours are available.

Kollektion von Hänge- und Wandleuchten mit einfachem und elegantem Design. Die Metallarmatur ist erhältlich in gold or nickel mit raffinierten 30% PbO Kristallen. Auf Anfrage sind originelle Lampenschirmen in verschiedenen Farben auch erhältlich.

Collection d'appliques et suspensions caractérisée par un design sobre mais élégant. La monture en métal est disponible dans la finition or ou nickel avec des bobèches et des crystals PbO 30%. Sur demande une gamme de paralumes en différentes couleurs est aussi disponible.

Serie de lámpara de luz difusa de pared y suspensión. Estructura de metal disponible en acabado oro y nickel; difusor de cristal 30% PbO. Accesorios: difusor de pongé disponible en varios colores.

Ordinare codice struttura + codice paralume / Order frame code + shade code / bestellen Artikelnummer Struktur + Artikelnummer Schirm /
Commander code structure + code paralume / Pedir código estructura + código pantalla



Oro



Cromo



Organza Plissé Nero
480034



Pongé Plissé Avorio
480035



Pongé Plissé Bianco
480036



Pongé Plissé Fucsia
480037



Pongé Plissé Rosso
480038

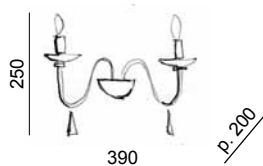
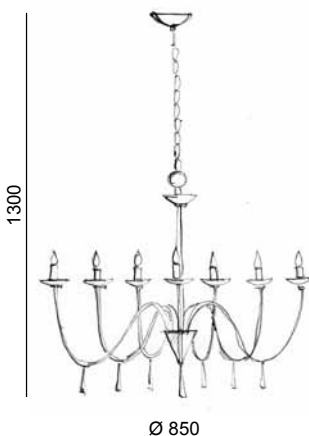

elettrificazione	colore	codice
8xE14 42W	Oro	S4087.01
8xE14 42W	Cromo	S4087.03

IP 20 V E CE

elettrificazione	colore	codice
2xE14 42W	Oro	S4087.05
2xE14 42W	Cromo	S4087.07

IP 20 V E CE





S4087.01 + 8x480038



S4087.05 + 2x480034

REDENTORE

Design Officina San Marco

Collezione di lampade da terra, tavolo, parete e sospensione. Forme essenziali in metallo finemente verniciato e decorato a mano che possono essere personalizzate con eleganti diffusori con doppio vetro o con semplici vetri bianchi.

Collection of pendant, wall, table and floor lamps characterized by clean yet elegant design. Metal frame, painted and hand decorated; on request a choice of double glass diffuser or simple white glass is available.

Klare und einfache Linien für diese Kollektion von Hänge-, Wand-, Tisch- und Standleuchten. Metallarmatur, lackiert und von Hand dekoriert; auf Anfrage sind Diffusors mit Doppel-glas oder einfache Weißgläser verfügbar.

Collection d'applique, lampadaire, lampe à poser et suspension au design sobre. Monture en métal vernisé, décorée à la main; sur demande des diffuseurs avec double verre ou un simple verre blanc sont disponibles.

Serie de lámpara de luz difusa de pared, mesa, de pie y suspensión. Estructura de metal pintado, decorada a mano. Difusor de cristal extra claro o doble cristal a elección.



Oro Bruno



Nikel Perlato



Oro Perlato

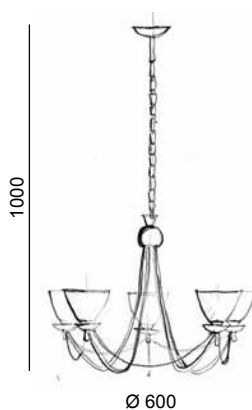
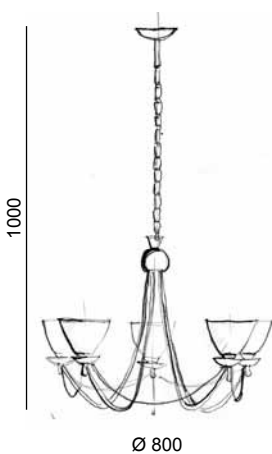

elettrificazione	colore	colore	colore
8xE14 42W	☉	Oro Bruno	S4008.19
8xE14 42W	☉	Nikel Perlato	S4008.20
8xE14 42W	☉	Oro Perlato	S4008.21

IP 20 ⚡ ⚠ CE

elettrificazione	colore	colore	colore
5xE14 42W	☉	Oro Bruno	S4008.22
5xE14 42W	☉	Nikel Perlato	S4008.23
5xE14 42W	☉	Oro Perlato	S4008.24

IP 20 ⚡ ⚠ CE

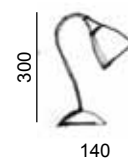
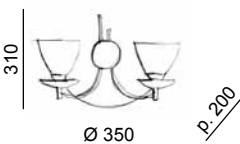
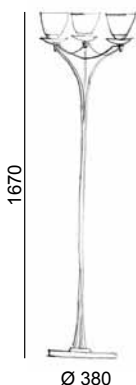

elettrificazione	colore	colore	colore
3xE14 42W	☉	Oro Bruno	S4008.31
3xE14 42W	☉	Nikel Perlato	S4008.32
3xE14 42W	☉	Oro Perlato	S4008.33

IP 20 ⚡ ⚠ CE

elettrificazione	colore	colore	colore
3xE14 42W	☉	Oro Bruno	S4008.25
3xE14 42W	☉	Nikel Perlato	S4008.26
3xE14 42W	☉	Oro Perlato	S4008.27

IP 20 ⚡ ⚠ CE

elettrificazione	colore	colore	colore
1xE14 42W	☉	Oro Bruno	S4008.28
1xE14 42W	☉	Nikel Perlato	S4008.29
1xE14 42W	☉	Oro Perlato	S4008.30

IP 20 ⚡ ⚠ CE



S4008.19



S4008.25



S4008.31



S4008.28



MURANO

Design Archivio San Marco

LED
SMD



Collezione di lampada da parete e soffitto: il diffusore di vetro in piastra con rugiada di vetro interno è lavorato a mano, come dalle antiche tradizioni dei vetrai di Murano. Disponibile anche con illuminazione a LED SMD multi-chip a luce bianca naturale.

Collection of ceiling and wall luminaires characterized by clean yet elegant design. Metal frame, hand-made curved cast glass according to the ancient tradition of the Murano glassmakers. Also available with multi-chip SMD LED natural white light.

Kollektion von Decken- und Wandleuchten. Metallarmatur und handgemachtes, gebogenes und gegossenes Glas nach der alten Tradition der Murano-Glaserbeiter. Die Leuchte ist auch mit LED SMD multi-chip erhältlich, weiß Tageslicht.

Collection d'applique et plafonnier au design sobre. Monture en métal et verre coulé et courbé en plaque selon l'ancienne tradition du verre de Murano. Le produit est aussi disponible dans la version avec LED SMD multi-chip, lumière blanche naturelle.

Serie de lámpara de luz difusa de pared y de techo. Plancha de cristal colado y curvado, cristal graniglia, detalle en cristal con hoja de oro. Disponible también con LED SMD multi-chip a luz blanca natural.



Oro



Cristallo

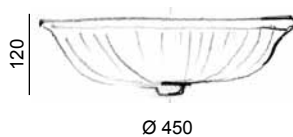
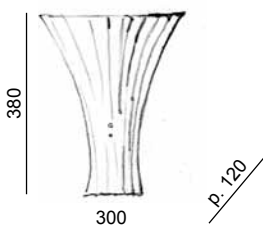

elettrificazione	finitura	codice
1xE27 42W	Oro	G0391.01
1xE27 42W	Cristallo	G0391.02
LED SMD 7.7W 4500K	Oro	G0391.11
LED SMD 7.7W 4500K	Cristallo	G0391.12

IP 20

elettrificazione	finitura	codice
3xE27 42W	Cristallo	G0390.03
1xLED SMD 19W 4500K	Cristallo	G0390.13

IP 20



G0390.03



G0391.01





G0391.02

DOGE

Design Archivio San Marco

LED
SMD



Collezione di lampade da parete con un particolare diffusore di vetro in piastra lavorato graniglia. Struttura in metallo verniciato. Disponibile anche con illuminazione a LED SMD multi-chip a luce bianca naturale.

Collection of wall luminaires characterized by clean yet elegant design. Painted metal frame, hand-made curved cast "graniglia" glass with a particular grit finish. Also available with multi-chip SMD LED natural white light.

Kollektion von Decken- und Wandleuchten. Metallarmatur und handgemachtes, gebogenes und gegossenes Glas mit Kies-Bearbeitung. Die Leuchte ist auch mit LED SMD multi-chip erhältlich, weiß Tageslicht.

Collection d'applique et plafonnier au design sobre. Monture en métal vernisé et verre en plaque avec finition grès. Le produit est aussi disponible dans la version avec LED SMD multi-chip, lumière blanche naturelle.

Serie de lámpara de luz difusa de pared y de techo. Plancha de cristal colado y curvado, cristal graniglia, detalle en cristal con hoja de oro. Estructura de metal pintado. Disponible tambien con LED SMD multi-chip a luz blanca natural.

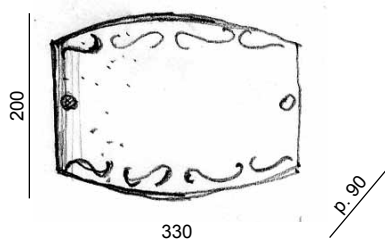
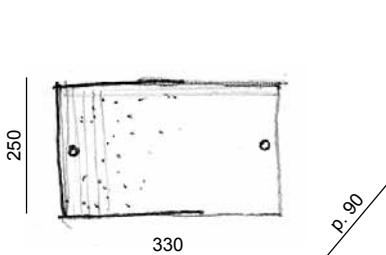

elettrificazione	finitura	codice
1xR7s 120W 118mm	Cristallo	G3121.03
LED SMD 7.7W 4500K	Cristallo	G3121.13



elettrificazione	finitura	codice
1xR7s 120W 118mm	Cristallo	G3122.03
LED SMD 7.7W 4500K	Cristallo	G3122.13









G3121.03

AIDA

Design Archivio San Marco

LED
SMD



Collezione di lampade da parete e soffitto. La struttura in metallo verniciato viene interamente ricoperta dalla cornice in legno abbinata al raffinato vetro satinato. Disponibile anche con illuminazione a LED SMD multi-chip a luce bianca naturale.

Collection of ceiling and wall luminaires. Simple painted metal gallery with a wooden frame and a satin glass. Also available with multi-chip SMD LED natural white light.



Kollektion von Decken- und Wandleuchten. Einfache lackierte Metallarmatur und Rahmen aus Holz. Abdeckung aus satiniertem Glas. Die Leuchte ist auch mit LED SMD multi-chip erhältlich, weiß Tageslicht.

Collection de plafonniers et appliques. Structure en métal vernisée; anneau en bois et verre satiné. Le produit est aussi disponible dans la version avec LED SMD multi-chip, lumière blanche naturelle.

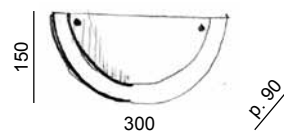
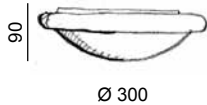
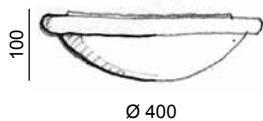

Serie de lámpara de luz difusa de pared y de techo. Estructura de metal pintado, cornisa en madera y difusor en vidrio satinado. Disponible también con LED SMD multi-chip a luz blanca natural.







elettrificazione	colore	codice
2xE27 42W 	Rovere	G0220.05
1xLED SMD 15W 4500K	Rovere	G0220.15

IP 20   

elettrificazione	colore	codice
1xE27 42W 	Rovere	G0220.03
1xLED SMD 9W 4500K	Rovere	G0220.13

IP 20   

elettrificazione	colore	codice
1xE27 42W 	Rovere	G0220.01
1xLED SMD 2.9W 4500K	Rovere	G0220.11

IP 20   





G0220.01

G0220.05

G0220.03

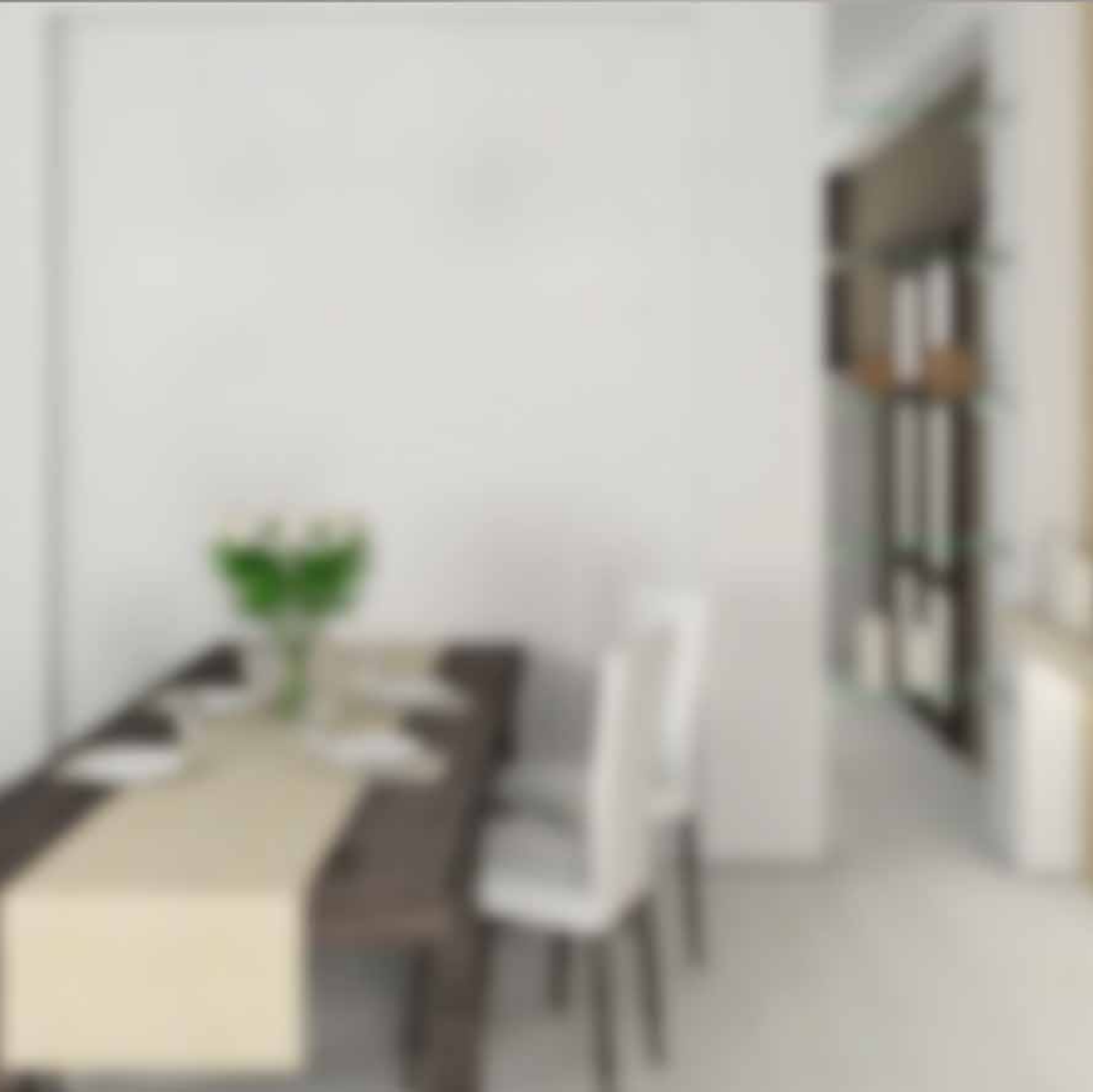

REGATA

Design Officina San Marco

Collezione di lampade da terra, tavolo, parete e sospensione. Una semplice struttura metallica verniciata e decorata a mano abbinata a diffusori in vetro satinato alabastro bianco.

Collection of pendant, wall, table and floor lamps characterized by clean yet elegant design. Metal frame, painted and hand decorated with white alabaster glass diffusers.

Klare und einfache Linien für diese Kollektion von Hänge-, Wand-, Tisch- und Standleuchten. Metallarmatur, lackiert und von Hand dekoriert mit weißen Alabastergläsern.

Collection d'applique, lampadaire, lampe à poser et suspension au design sobre. Monture en métal vernisé, décorée à la main avec des diffuseurs en verre albâtre blanc.

Serie de lámpara de luz difusa de pared, mesa, de pie y suspensión. Estructura de metal pintado, decorada a mano. Difusor en vidrio satinado alabastro.

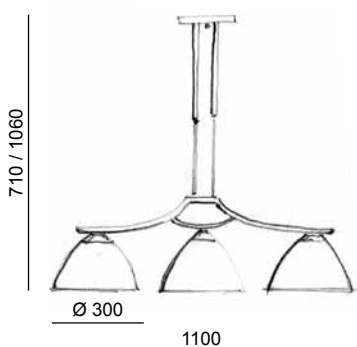

elettrificazione	colore	codice
3xE27 42W	Oro Bruno	S4190.02

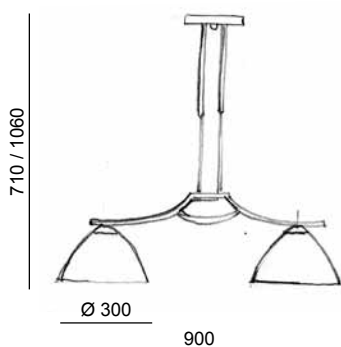

elettrificazione	colore	codice
2xE27 42W	Oro Bruno	S4190.01

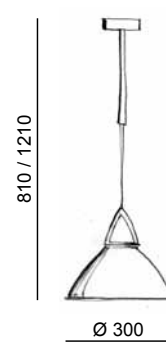

elettrificazione	colore	codice
1xE27 42W	Oro Bruno	S4190.03

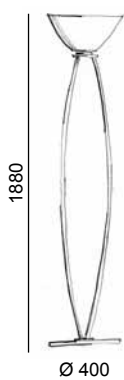

elettrificazione	finitura	codice
1xE27 42W	Oro Bruno	S4190.04

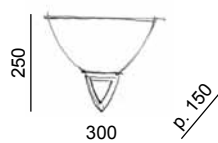

elettrificazione	finitura	codice
1xE27 42W	Oro Bruno	S4190.05



S4190.03



S4190.02





S4190.04



POESIA

Design Archivio San Marco

Collezione di lampade a sospensione. Semplici particolari di metallo con finitura antichizzata e decorata a mano, abbinati ad eleganti diffusori in vetro scavo.





Collection of pendant luminaires. Simple metal frame with hand painted antique finish details and elegant frosted "scavo" glass diffusers.

Kollektion von Hängeleuchten. Einfache lackierte Metallarmatur, Antik-Ausführung und "scavo" Glas.

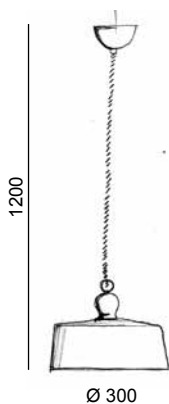



Collection de suspensions. Monture en métal, finition antiquisée et décorée à la main; verre "scavo".

Serie de lámpara de luz difusa de suspensión. Estructura de metal, acabado en cobre y cristal excavado.

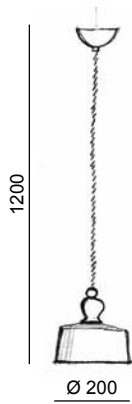





elettrificazione	finitura	codice
1xE27 52W 	Bianco	G1003.02
	   	

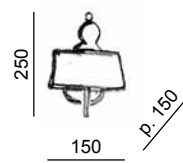

elettrificazione	finitura	codice
1xE27 52W 	Bianco	G1003.01
	   	



elettrificazione	finitura	codice
1xE14 28W 	Bianco	G1003.04
	   	



G1003.01





ASTER

Design Archivio San Marco

Collezione di lampade da tavolo, parete e sospensioni. Una semplicissima montatura in metallo verniciato con decoro a mano abbinata ad eleganti diffusori in vetro scavo.





Collection of table, pendant and wall luminaires. Painted metal frame with hand decorated details; frosted "scavo" glass diffusers.



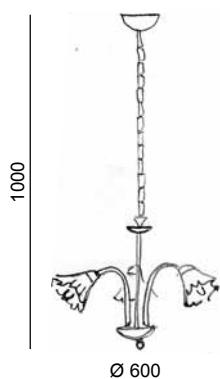
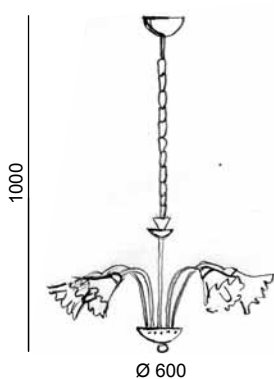

Kollektion von Tisch-, Hänge- und Wandleuchten. Einfache lackierte Metallarmatur; Antik-Ausführung und "scavo" Glas.

Collection de suspensions, lampes à poser et appliques. Monture en métal vernisé; diffuseur en verre "scavo".





Serie de lámpara de luz difusa de pared, mesa y suspensión. Estructura de metal pintado; cristal excavado.



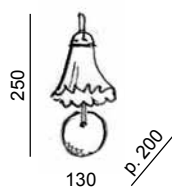
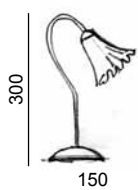



elettrificazione	finitura	codice
5xE14 28W	Marrone	G1031.06
   		

elettrificazione	finitura	codice
3xE14 28W	Marrone	G1031.04
   		



elettrificazione	finitura	codice
1xE14 28W	Marrone	G1031.08
   		

elettrificazione	finitura	codice
1xE14 28W	Marrone	G1031.02
   		



G1031.06



G1031.02



G1031.08



DALIA

Design Archivio San Marco

Collezione di sospensioni e lampade da parete a luce diretta. La montatura in metallo verniciato e decorata a mano viene completata dai particolari e dai riflettori in ceramica decorata a mano.

Collection of pendant and wall luminaries giving accent light. Painted metal frame with hand decorated details and ceramic diffusers.

Kollektion von Hänge- und Wandleuchten mit direktem Licht. Lackierte Metallarmatur und Diffusor aus Keramik.

Collection de suspensions et appliques à lumière directe. Monture en métal vernisé; diffuseur en céramique décorée à la main.

Serie de lámpara de luz difusa de pared y suspensión. Estructura de metal pintado; difusor de ceramica decorada.

decorato a mano / hand painted / hand bemalt / décoré à la main / decorado a mano

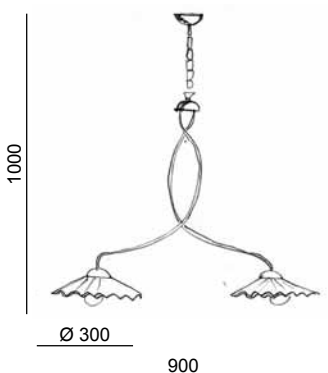

elettrificazione	colore	codice
2xE27 42W	Marrone	G1042.10

IP 20

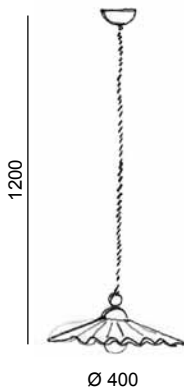

elettrificazione	colore	codice
1xE27 52W	Marrone	G1042.08

IP 20

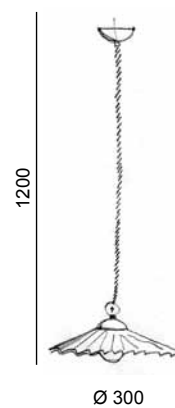

elettrificazione	colore	codice
1xE27 52W	Marrone	G1042.06

IP 20

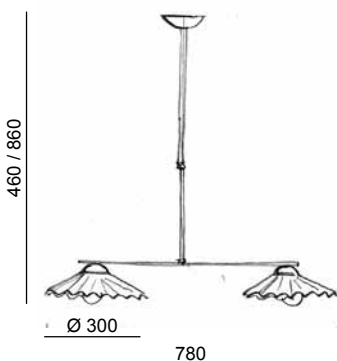

elettrificazione	colore	codice
2xE27 42W	Marrone	G1182.10

IP 20

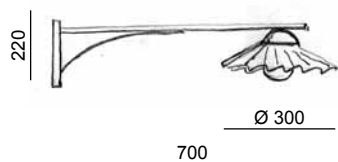

elettrificazione	colore	codice
1xE27 42W	Marrone	G1182.04

IP 20

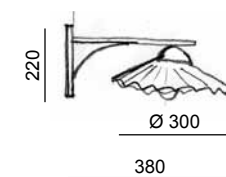

elettrificazione	colore	codice
1xE27 42W	Marrone	G1182.02

IP 20



G1042.06



G1042.10



G1182.10

G1182.02





G1182.04

G1042.06

COROLLA

Design Archivio San Marco

Collezione di lampade da tavolo e da parete a luce diretta. La semplice montatura in metallo verniciato, decorato a mano, viene completata da eleganti riflettori in ceramica decorata.

Collection of table and wall luminaries giving direct light. Ceramic structure with hand decorated details and ceramic diffusers.

Kollektion von Tisch- und Wandleuchten mit direktem Licht. Struktur und Diffusor aus lackierter Keramik.

Collection de lampes à poser et appliques à lumière directe. Structure et diffuseur en céramique décorée à la main.

Serie de lámpara de luz de acento de mesa y suspensión. Estructura y difusor de cerámica decorada.

decorato a mano / hand painted / hand bemalt / décoré à la main / decorado a mano

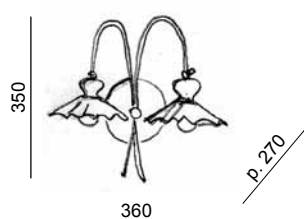

elettrificazione	colore	codice
2xE14 28W	Marrone	G1170.04
	IP 20	VF
	⊕	CE

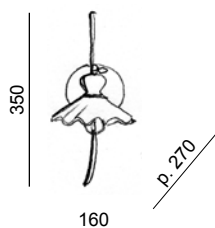

elettrificazione	colore	codice
1xE14 28W	Marrone	G1170.02
	IP 20	VF
	⊕	CE

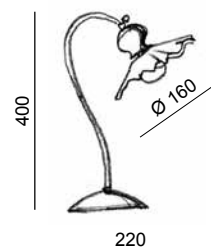

elettrificazione	colore	codice
1xE14 28W	Marrone	G1170.06
	IP 20	VF
	⊕	CE







G1170.04



G1170.06

GAIA

Design Archivio San Marco

Collezione di lampade da tavolo, parete e sospensioni. Una semplicissima montatura in metallo verniciato con decoro a mano abbinata ad eleganti diffusori in vetro bianco satinato con particolari in ceramica decorata a mano.

Collection of table, pendant and wall luminaires. Painted metal frame with hand decorated details; satin glass diffusers and hand painted ceramic parts.

Kollektion von Tisch-, Hänge- und Wandleuchten. Einfache lackierte Metallarmatur; satiniertes Glasdiffusor mit Details aus Keramik.

Collection de suspensions, lampes à poser et appliques. Monture en métal vernisé; diffuseur en verre satiné et détails en céramique décorée à la main.

Serie de lámpara de luz difusa de pared, mesa y suspensión. Estructura de metal pintado; cristal satinado blanco y acabado en ceramica.

decorato a mano / hand painted / hand bemalt / décoré à la main / decorado a mano

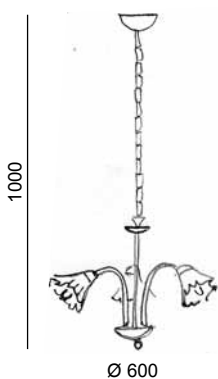
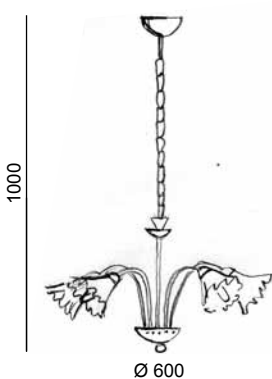

elettrificazione	finitura	codice
5xE14 28W	Marrone	G1030.06
	IP 20	VF
		CE

elettrificazione	finitura	codice
3xE14 28W	Marrone	G1030.04
	IP 20	VF
		CE

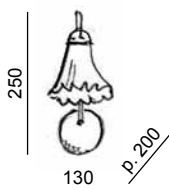
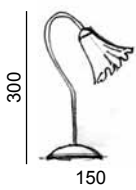

elettrificazione	finitura	codice
1xE14 28W	Marrone	G1030.08
	IP 20	VF
		CE

elettrificazione	finitura	codice
1xE14 28W	Marrone	G1030.02
	IP 20	VF
		CE



G1030.02





G1030.08





DUSE

Design Archivio San Marco

Collezione di sospensioni e lampade da parete e a soffitto a luce diretta. La montatura e i riflettori sono in ceramica decorata a mano.

Collection of pendant and wall luminaries giving direct light. Ceramic structure with hand decorated details and ceramic diffusers.

Kollektion von Hänge- und Wandleuchten mit direktem Licht. Struktur und Diffusor aus lackierter Keramik.

Collection de suspensions et appliques à lumière directe. Structure et diffuseur en céramique décorée à la main.

Serie de lámpara de luz de acento de pared y suspensión. Estructura y difusor de ceramica decorada.

decorato a mano / hand painted / hand bemalt / décoré à la main / decorado a mano

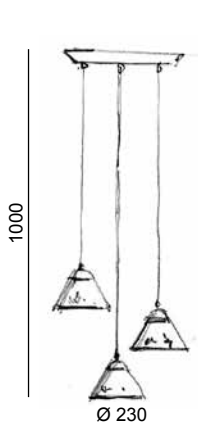

elettrificazione	colore	codice
3xE14 28W	Marrone	G1001.12
	IP 20	CE

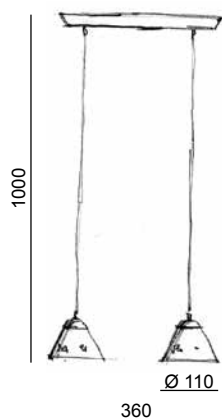

elettrificazione	colore	codice
2xE14 28W	Marrone	G1001.10
	IP 20	CE

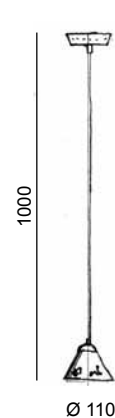

elettrificazione	colore	codice
1xE14 28W	Marrone	G1001.08
	IP 20	CE

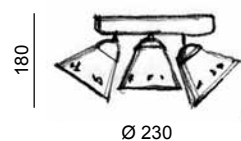

elettrificazione	colore	codice
3xE14 28W	Marrone	G1001.06
	IP 20	CE

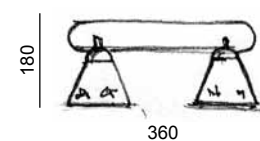

elettrificazione	colore	codice
2xE14 28W	Marrone	G1001.04
	IP 20	CE

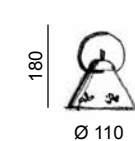

elettrificazione	colore	codice
1xE14 28W	Marrone	G1001.02
	IP 20	CE



G1001.12



G1001.04



G1001.10



G1001.06



G1001.02



G1001.08

GIADA

Design Archivio San Marco

Collezione di sospensioni e lampade da parete a luce diretta. La montatura in metallo verniciato e decorato viene completata dai particolari in ceramica decorata a mano e dai riflettori in metallo antichizzato.

Collection of pendant and wall luminaries giving direct light. Metal frame available in a hand painted antique finish and ceramic diffusers.

Kollektion von Hänge- und Wandleuchten mit direktem Licht. Lackierte Metallarmatur, Antik-Ausführung und Diffusor aus Keramik.

Collection de suspensions et appliques à lumière directe. Monture en métal, finition antiquisée et décorée à la main; diffuseur en céramique.

Serie de lámpara de luz de acento de pared y suspensión. Estructura de metal, acabado en cobriza y difusor de ceramica.

decorato a mano / hand painted / hand bemalt / décoré à la main / decorado a mano

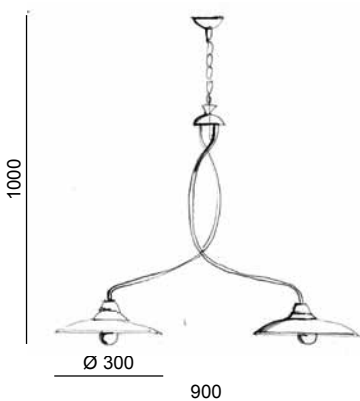

elettrificazione	colore	codice
2xE27 42W	Marrone	G1040.08

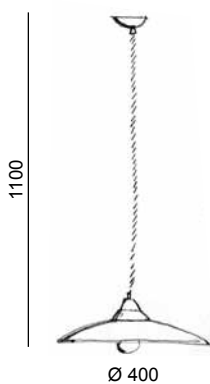

elettrificazione	colore	codice
1xE27 52W	Marrone	G1040.06

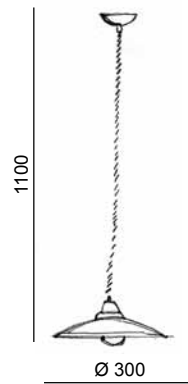

elettrificazione	colore	codice
1xE27 52W	Marrone	G1040.04

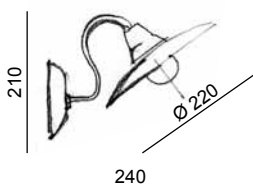

elettrificazione	colore	codice
1xE27 42W	Marrone	G1040.02





G1040.08



G1040.02



G1040.06



G1040.04

FIAMMA

Design Archivio San Marco

Collezioni di lampade da parete e soffitto. La struttura e i particolari sono in ceramica decorata a mano e viene addolcita da snodi in metallo brunito e vetri satinati bianchi.

Collection of ceiling and wall luminaires. Hand decorated ceramic frame with bronzed metal joint and white satin glass.





Kollektion von Decken- und Wandleuchten. Lackierte Armatur aus Keramik mit gebräuntem Metall-Gelenk und Diffusor weiß satiniert.

Collection de plafonniers et appliques. Structure en céramique décorée à la main avec rotule en métal bruni et verre satiné blanc.

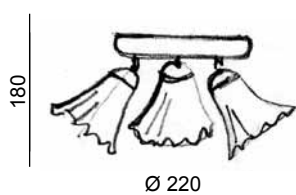



Serie de lámpara de luz difusa de pared y suspensión. Estructura de cerámica con fuente orientable en metal brunito y difusor de vidrio satinado.

decorato a mano / hand painted / hand bemalt / décoré à la main / decorado a mano

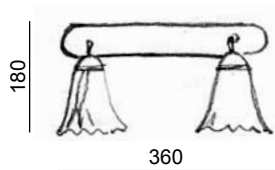





elettrificazione	finitura	codice
3xE14 28W 	Marrone	G0585.06
IP 20    CE		

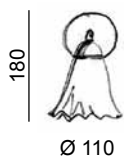

elettrificazione	finitura	codice
2xE14 28W 	Marrone	G0585.04
IP 20    CE		



elettrificazione	finitura	codice
1xE14 28W 	Marrone	G0585.02
IP 20    CE		





G0585.06



G0585.04

LEGENDA FINITURE / FINISH LEGEND

acciaio steel Stahl acier acero	bianco white weiß blanc blanco	grigio gray grau gris gris	oro gold gold or oro	satinato satin satin satin satinado
alluminio aluminium aluminium aluminium aluminio	blu blue blau bleu azul	marrone brown braun marron marrón	oro bruno gold brown gold braun or brun oro bruno	silver silver silber silver silber
ambra amber amber ambre ámbar	cristallo crystal kristall cristal cristal	multicolore multicolour multicolor multicolore multicolor	oro opaco matt gold gold matt or matt oro matte	spezzato broken segments Streifendekor lignes cassées lineas quebradas
arancio orange orange orange naranja	cromo chrome chrom chrome cromo	nero black schwarz noir negro	oro perlato pearly gold Perlgold or perle oro perlado	trasparente transparent transparent transparent transparente
argento silver silber argent plata	damascato damask design damassé damast damascado	nichel opaco matt nickel nickel matt nickel matt niquel matte	ottone brass messing laiton latón	vetro specchio mirror glass Spiegelglas verre glace vidro espejo
azzurro light blue blau azur azul	foglia argento silver foil blattsilber feuille d'argent pan de plata	nichel perlato pearly nickel Perlnickel nickel perle niquel perlado	palissandro rosewood palisander rosewood palisandro	wengé wenge wenge wenge wenge
beige beige beige beige beige	foglia oro gold foil blattgold feuille d'or pan de oro	nichel spazzolato brushed nickel nickel gebürstet nickel brossé niquel bruñido	rovere oak finish Eichen Ausführung rouvre roble	

PARALUMI / LAMP SHADES



480034
organza plissé nero
black pleated organza
schwarzer plissierter Organza
organdi plissé noir
teijdo organza plisado negro



480035
pongé plissé avorio
pleated pongé cream colour
plissierter Pongé elfenbeinfarbig
pongé plissé couleur ivoire
teijdo pongé plisado color marfil



480036
pongé plissé bianco
pleated pongé white
plissierter Pongé weiß
pongé plissé blanc
teijdo pongé plisado blanco





480037
pongé plissé fucsia
pleated pongé fuchsia
plissierter Pongé fuchsiafarbig
pongé plissé couleur fuchsia
teijdo pongé plisado color fucsia







480038
pongé plissé rosso
pleated pongé red
plissierter Pongé rot
pongé plissé rouge
teijdo pongé plisado rojo



Lampadine ad incandescenza

Sigla	Tipo	Attacco	Potenza (W)	Flusso luminoso (Lm)	Lumen/Watt	Codice
	chiara	E14	28	320	11.5	-
	chiara	E14	42	580	13.8	-
A55 	chiara	E27	28	345	12.3	-
	chiara	E27	42	630	15.0	-
	chiara	E27	52	820	15.7	-
	chiara	E27	70	1200	15.4	-
	chiara	E27	105	1900	18.9	-
GLOBOLUX 		E27	60	600	10.0	-
		E27	100	1000	10.0	-







Lampadine alogene tensione di rete 220v

Sigla	Tipo	Attacco	Potenza (W)	Flusso luminoso (Lm)	Lumen/Watt	Codice
QT HALOLUX 	chiara	E27	75	1100	14.7	-
	chiara	E27	100	1500	15.0	970118
	chiara	E27	150	2500	16.7	970119
	chiara	E27	250	4200	16.8	970120
QT DE LINEARE 	chiara 75mm	R7s	80	1450	18.1	-
	chiara 75mm	R7s	120	2300	19.1	-
	chiara 118mm	R7s	120	2440	20.3	-
	chiara 118mm	R7s	160	3300	20.6	-
	chiara 118mm	R7s	230	5000	21.7	-
G9 	chiara	G9	20	200	10.0	-
	chiara	G9	33	460	13.9	-
	chiara	G9	48	740	15.4	-
GU10 	35°	GU10	50	950	19.0	970110
	50°	GU10	50	600	12.0	-

Lampadine alogene bassa tensione 12v

Sigla	Tipo	Attacco	Potenza (W)	Flusso luminoso (Lm)	Lumen/Watt	Codice
HALOSPOT 111 	8°	G53	50	33000 (cd)	-	970106
	24°	G53	50	5800 (cd)	-	970150
	45°	G53	50	2000 (cd)	-	-

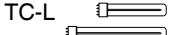
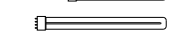
Lampadine fluorescenti compatte

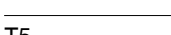
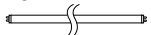
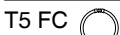
Sigla	Tipo	Attacco	Potenza (W)	Flusso luminoso (Lm)	Lumen/Watt	Codice
TC-S 		G23	9	600	66.7	970005
		G23	11	900	81.8	-
TC-D 		G24d2	18	1200	66.7	970020
		G24d3	26	1800	69.2	970021
TC-D/E 		G24q2	18	1200	66.7	970023
		G24q3	26	1800	69.2	970024
TC-T/E  		GX24q2	18	1200	66.7	970063
		GX24q3	26	1800	69.2	970064
		GX24q3	32	2400	75.0	970065
		GX24q4	42	3200	76.2	970066
TC-L    		2G11	18	1200	66.7	970000
		2G11	24	1800	75.0	970001
		2G11	36	2900	80.6	970002
		2G11	55	4800	87.3	970003
T5 	FQ	G5	24	2000	83.3	970030
	FQ	G5	39	3500	87.7	970031
	FQ	G5	54	5000	92.6	970035
T5 FC 	FC	2GX13	22	1800	81.8	-
	FC	2GX13	40	3300	82.5	-

Lampadine fluorescenti elettroniche compatte





Sigla	Tipo	Attacco	Potenza (W)	Flusso luminoso (Lm)	Lumen/Watt	Codice
		E27	11	600	54.5	-
		E27	15	900	60.0	970017
		E27	20	1200	60.0	970018
		E27	23	1500	65.2	-

Indice protezione IP XY Protective degree

Il prefisso IP (International Protection), seguito da due cifre significative, indica la resistenza offerta dall'apparecchio alla penetrazione di solidi e liquidi.
The code IP (International Protection), followed by two significant numbers, states the resistance of the fitting to the penetration of solids and liquids.

La prima cifra identifica il grado di protezione contro l'ingresso di corpi solidi. <i>The first number identifies the protection degree against the entry of solid bodies.</i>	La seconda cifra identifica il grado di protezione contro l'ingresso di liquidi. <i>The second number identifies the protection degree against the entry of liquids.</i>
<p>IP 1Y Protetto contro la penetrazione di corpi solidi di dimensioni superiori a 50 mm. <i>Protected against the entry of solid bodies with dimensions of more than 50 mm.</i></p> <p>IP 2Y Protetto contro la penetrazione di corpi solidi di dimensioni superiori a 12 mm. <i>Protected against the entry of solid bodies with dimensions of more than 12 mm.</i></p> <p>IP 3Y Protetto contro la penetrazione di corpi solidi di dimensioni superiori a 2,5 mm. <i>Protected against the entry of solid bodies with dimensions of more than 2,5 mm.</i></p> <p>IP 4Y Protetto contro la penetrazione di corpi solidi di dimensioni superiori a 1 mm. <i>Protected against the entry of solid bodies with dimensions of more than 1 mm.</i></p> <p>IP 5Y Protetto contro la penetrazione della polvere. <i>Protected against entry of dust.</i></p> <p>IP 6Y Protetto completamente contro la penetrazione della polvere. <i>Completely protected against entry of dust.</i></p>	<p>IP X0 Non protetto. <i>Unprotected.</i></p> <p>IP X1 Protetto contro le cadute verticali di gocce d'acqua. <i>Protected against the vertical falling of water drops.</i></p> <p>IP X2 Protetto contro le cadute dell'acqua con inclinazione massima di 15°. <i>Protected against the falling of water with maximum inclination of 15°.</i></p> <p>IP X3 Protetto contro la pioggia. <i>Protected against the rain.</i></p> <p>IP X4 Protetto contro gli spruzzi. <i>Protected against sprinklings.</i></p> <p>IP X5 Protetto contro i getti d'acqua. <i>Protected against water jets.</i></p> <p>IP X6 Protetto contro le ondate. <i>Protected against heavy waves.</i></p> <p>IP X7 Protetto contro l'immersione temporanea. <i>Temporary immersion proof.</i></p>

Legenda simboli Symbols

	<p>CLASSE I CLASS I</p>	<p>Apparecchi con parti metalliche costantemente collegate al circuito di terra. <i>Equipment with metal parts constantly connected to the earth circuit.</i></p>
	<p>CLASSE II CLASS II</p>	<p>Apparecchi con parti in tensione isolate tra loro e verso l'esterno con un doppio isolamento e senza dispositivi di messa a terra. <i>Equipment with live parts insulated from one another and from the outside with double insulation and without earthing devices.</i></p>
	<p>CLASSE III CLASS III</p>	<p>Apparecchi alimentati con tensione di sicurezza inferiore ai 50V. <i>Equipment powered with safety voltage lower than 50V.</i></p>
	<p>Conforme alle direttive CEE. <i>Conformity with CEE directives.</i></p>	
	<p>Apparecchi idonei per essere montati su superfici normalmente infiammabili. <i>Equipment suitable to be fitted on normally inflammable surfaces.</i></p>	

Tutti i prodotti di questo catalogo sono conformi alla direttiva RoHS (normativa 2002/95/CE).
All of the product in this catalogue are in compliance with the RoHS directive 2002/95/CE.

A norma della Direttiva Europea 2000/55/EC sugli alimentatori per lampade fluorescenti si ricorda:
 "BALLAST MAGNETICI fino alla classe B2 sono banditi dal 01/09/2005"

*According to the European Directives 2000/55/EC on the ballasts for fluorescent lamps, we remind that
 "Magnetic Ballasts until Class B2 cannot be used from 01/09/2005"*

Nonostante l'impegno di fornire informazioni sempre più accurate, i dati riferiti ai prodotti, che RggCo. SRL divulga in buona fede, sono da ritenersi puramente indicativi.

Nella continua ricerca di miglioramenti tecnici e funzionali, RggCo. SRL si riserva il diritto di apportare, in qualsiasi momento, modifiche anche sostanziali ai prodotti.

Tutte le lampade illustrate in questo catalogo unitamente a tutto quanto in esso contenuto (testi, disegni, immagini) sono di proprietà di RggCo. SRL e sono protetti dal Diritto di Riproduzione.

La marcatura CE indica che il prodotto soddisfa gli obblighi di legge in merito alle Direttive Comunitarie Europee applicabili allo stesso.

Garanzia - L'azienda produttrice garantisce il prodotto secondo le attuali Normative Europee. La garanzia prevista, comunque, non è operante nel caso di danni causati dal montaggio non a regola d'arte di terzi, di manomissione del manufatto e quant'altro non riferibile a difetti originari e/o di costruzione.

At RggCo. SRL we are committed to providing completely accurate information. However, the data contained in the present catalogue are published in good faith only and should be considered as purely indicative.

All the luminaires illustrated in detail in this catalogue and all the materials pertaining there to (texts, drawings, photographs) are under Copyright protection.

The CE symbol is your assurance that the product bearing the mark meets all the requirements prescribed by law, as contained in the Europea Community directives which apply to that product.

Guarantee - The manufacturer guarantees its products according to the current European Directives. The guarantee on our products is not valid in case of any alterations or damage resulting from adaptations, changes or adjustments which may have been made to the product without the prior written consent of the manufacturer.

Obwohl wir uns darum bemühen, immer präzisere Informationen zu geben, sind die Daten, welche von der Fa. RggCo. SRL in gutem Glauben verbreitet werden, als reine Richtwerte anzusehen. Alle Abbildungen und Angaben bezüglich Maße, Farbe usw unterliegen eventuellen produktionstechnischen Toleranzen und sind unverbindlich. Produktänderungen behalten wir uns jederzeit vor. RUGGIU steht für höchste Sicherheit und Qualität; alle unsere Artikel entsprechen den festgelegten europäischen Normen.

Garantie: die Herstellerfirma garantiert seine Produkte gemäß der aktuellen Europäischen Normen. Der Hersteller übernimmt keine Verantwortung für Verletzungen oder Schäden, die die Folge unsachgemässen Gebrauchs der Leuchte sind.

Malgré tous nos efforts pour fournir des informations de plus en plus précises, les données inhérentes aux performances que RggCo. SRL communique en toute bonne foi ne doivent être considérés qu'à titre indicatif.

Tous les produits illustrés dans ce catalogue (texts, dessins, images) sont protégés par le droit de reproduction. Le symbole CE indique que le produit est conforme aux obligations législatives des directives communautaires applicables à ce produit-là.

Garantie - Tous nos produits bénéficient d'une Garantie Constructeur selon les Normes Européennes courantes. La garantie ne s'applique pas à tout dommage causé par le non-respect des instructions d'utilisation du produit.

No obstante el empeño por suministrar informaciones cada vez mas precisas, los datos que se rifieren a las prestaciones que el RggCo. SRL divulga de buena fe, se deben considerar como puramente indicativos.

Todos los modelos ilustradas de manera mas exacta en el presente catalogo junto a todo lo que contiene (textos, disenos, imagenes), estan protegidos por el derecho de reproduccion.

Garantía - La empresa fabricante garantiza el producto según la normativa vigente en el país en que se comercializa el producto. La garantía prevista, pierde su validez por daños causados en el montaje ó en su manipulación, y por no cumplir las instrucciones de uso ó instalación y por cualquier otro motivo ajeno a defectos de fabricación.



GIODI

Largo San Giorgio, 6 - 30033 Noale (Venezia) Italia

ph +39 0422 485200

fax + 39 0422 487742

p.i. 04240140279

rggco@yahoo.it

info@ruggiu.it

GIODI *inspiration of light*

is a brand of:



ruggiu.com